





# Contents

## 4 Introduction

---

### Products for Trace Analysis

- 6–7 Analytik Jena® multi X 2500, multi EA 5100, multi EA 5000
  - 8–9 Antek® MultiTek, 9000 Series & 7000 Series
  - 10 Metrohm® 930 Combustion IC (AJ furnace & ABD)
  - 11–12 Elementar® trace SN cube
- 

### Products for TOC Analysis

- 13 Reference materials for TOC analysis
  - 14–15 Analytik Jena® multi EA 4000, multi N/C 3100 (duo, pharma), multi N/C 2100S (duo, pharma)
  - 16–18 Elementar® enviro TOC, vario TOC cube, vario TOC select
  - 19 Elementar® soli TOC cube
  - 20–21 Shimadzu® TOC-L, TOC-V, TOC-4110 series
  - 22 Skalar® Primacs Series
- 

### Legacy Instruments

- 23–24 Thermo Euroglas® TOC1200, ECS1200, TN3000, TS3000, ECS3000
- 

## 25 Dionex™ Vials, Caps & Accessories

---

## 27 Cross References

---

The use of OEM names or part numbers is intended for convenience only, and does not imply that the products are of OEM origin unless specified. All Elemental Microanalysis products are guaranteed to be of high quality and are deemed to be suitable alternatives in the stated instruments. All OEM trademarks acknowledged.

---

Information in this catalogue is correct at time of printing, but may be subject to change. Please refer to our website for the latest information.

---



## Introduction

### About the Company

Elemental Microanalysis has grown from small beginnings over 45 years ago as a micro-analytical laboratory to be a leading manufacturer and supplier of consumables, laboratory supplies and other products for elemental analysers. We operate from our purpose-built factory, warehouse and laboratory complex in Devon, UK.

As the leading independent supplier of elemental analysis consumables, we can offer substantial savings in comparison to the prices charged by the original supplier of your instrument. But we know that you need more from a supplier than simply low prices. You need to buy with the confidence that your analysis will not be compromised by poor quality consumables and the knowledge that your supplier has all the resources to provide the full range of support that you expect.

**'Price is what you pay, value is what you get'.**

You learn a lot in 45 years – a lot about your products – how to make them and how to use them, a lot about your customers and their needs. We have been developing, refining and using products for elemental analysis since 1976 and have a unique in-depth knowledge of instruments from all manufacturers.

These days we offer the world's largest range of quality products for elemental analysis, sending our products to customers across the globe. We take great pride in the quality of our products.



All products which we manufacture in-house use our ISO 9001:2015 certified quality system, implemented by our highly trained technicians.

We don't just make CRMs and consumables – we use them every day in our UKAS 17025 accredited analytical laboratory (CHNOS, IRMS and CIC analysis), which affords us constant feedback on proven performance. We do not compromise on quality and don't expect you to either. Our total satisfaction guarantee backs up our commitment to our product quality.

We will always treat our customers with honesty and integrity. If we do make a mistake, we don't try to hide it – we recognise it and put it right. We won't sell you short measure and we won't mislead you in any way. Our business is built on long-term relationships, as our customers will testify – many have been with us for more than 35 years!

### Guaranteed quality

Our company's management system is certified to ISO 9001:2015 by LRQA, we have an ISO/IEC 17025:2017 UKAS accredited Testing Laboratory, and we are an ISO/IEC 17034:2016 UKAS accredited Reference Materials Producer. Our confidence in our products allows us to offer you a total satisfaction guarantee: if our product does not perform at least as well as the brand of product you usually use, you can return it for a full refund.





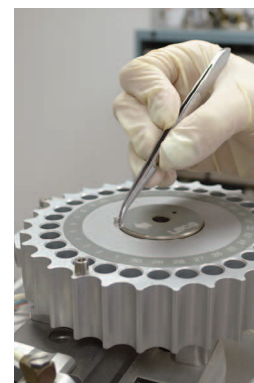
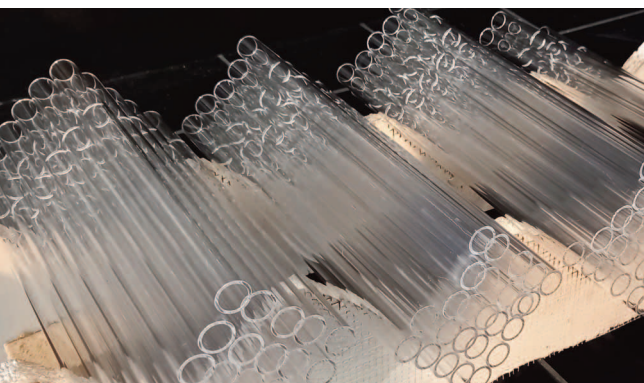

'price is what you pay –  
value is what you get'

### Technical service

In this catalogue we have tried to provide the most accurate and complete information possible about our ever-expanding range. We realise, however, that you may require additional technical information. For this reason we have technical specialists on hand to answer your questions and advise you on selecting the products best suited to your needs (email [enquiries@microanalysis.co.uk](mailto:enquiries@microanalysis.co.uk)). We can also supply samples, and even develop new products for your particular application.

### Customer service

Our friendly Customer Service Staff will ensure that your order is despatched promptly and correctly. They can tell you about our stock levels, prices, shipping arrangements, or answer any other queries you may have. Most orders are despatched within 24 hours of receipt. Rush orders receive special attention and are processed immediately. If you have an urgent problem or need priority despatch, please let us know.

### Try our products – free of charge!

Try before you buy – we have sample packs available for most elemental analysers on the market. Just let us know the instrument you have and we will send you a trial quantity of 3 or 4 different consumables to try – free and with no obligation. Offer limited to one per customer.

### Expanding offerings

We are constantly working on improving our products and these improvements may mean that some products differ from the descriptions in this catalogue. Our technical staff are happy to discuss any improvements made, and the resulting benefits. To keep up-to-date with the latest products and developments, visit our website ([elementalmicroanalysis.com](http://elementalmicroanalysis.com)), join our mailing list for updates delivered straight to your inbox (sign up on our website), or check in on your schedule by following us on LinkedIn or on X (@elementallab).

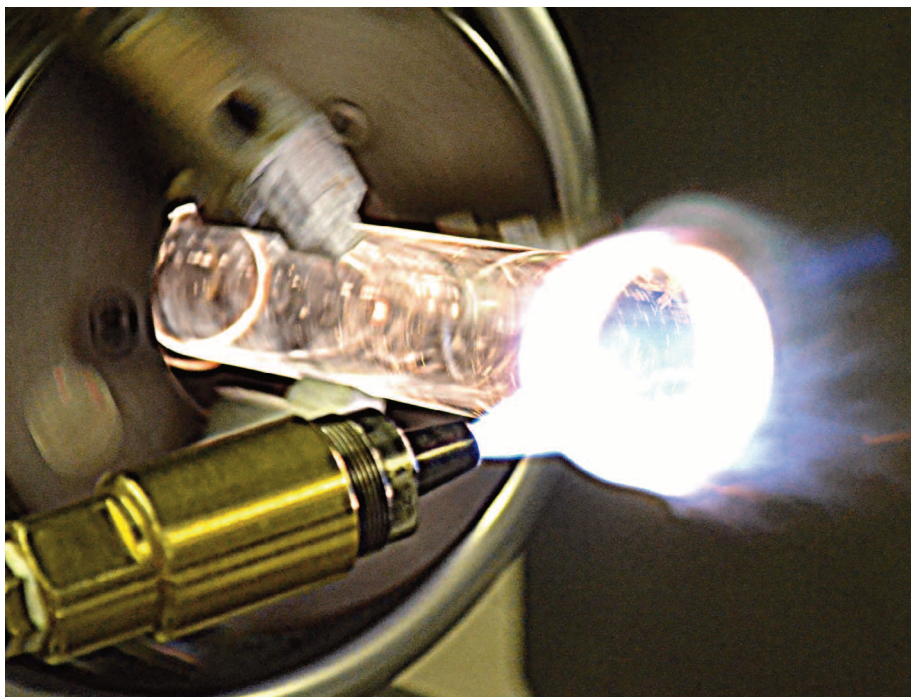

## Analytik Jena® multi X 2500, multi EA 5100, multi EA 5000

Further parts for other Analytik Jena® instruments are featured in the TOC section on pages 14 & 15

### Quartz, glassware & boats

Part No	Description	Pack	Analytik Jena® part	multi X 2500	multi EA 5000	multi EA 5100
C8134	Ceramic boat for sample injection in combustion module	10		✓	✓	✓
C3215	Glass tube with thread, straight, (without connectors)	1	402-881.203	✓		
X4020	Halogen absorber, complete with U-tube, 11 mm	1	402-885.019	✓	✓	✓
C3214	Multi-purpose combustion tube	1	402-889.510	✓	✓	✓
C5201	Quartz hook for ABD	1	402-889.066	✓		
C8133	Quartz sample boat 40 x 9 mm	10	402-889.674	✓	✓	✓
C8135	Quartz sample boats with downholder 40 x 9 mm	10	402-899.673	✓	✓	✓
C3204	U-tube, OD 11 mm, without filling for halogen absorber	1	402-825.150	✓	✓	✓

Ceramic sample boats  
C8134



Quartz sample boats 40 x 9 mm  
C8133



Quartz sample boats with downholder  
C8135



Quartz hook for ABD  
C5201

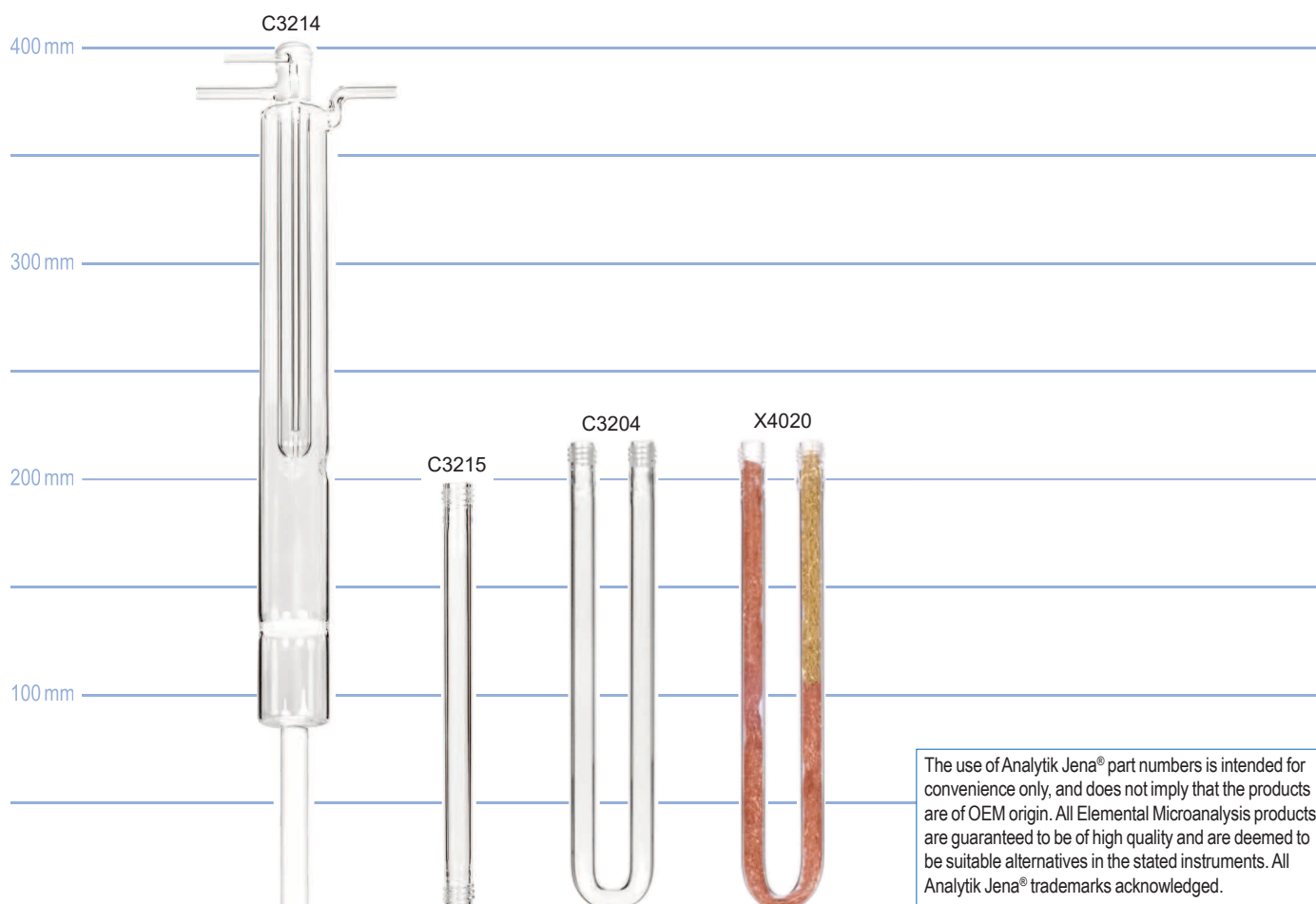

The use of Analytik Jena® part numbers is intended for convenience only, and does not imply that the products are of OEM origin. All Elemental Microanalysis products are guaranteed to be of high quality and are deemed to be suitable alternatives in the stated instruments. All Analytik Jena® trademarks acknowledged.



# Analytik Jena® multi X 2500, multi EA 5100, multi EA 5000

## Reagents & tube packings

Part No	Description	Pack	Analytik Jena® part
B1725	Activated carbon for AOX analysis	10 g	402-810.004
B1161	EMADrone, magnesium perchlorate	454 g	402-886.116
B1720	Halogen absorber filling for GL14 tube (copper and brass wool)		402-810.050
B1724	Special catalyst, platinum	20 g	402-810.048
B1726	Special catalyst, platinum	approx. 80 ml	402-810.059
B1729	Quartz glass culet, coarse grains	80 g	402-881.006
B1460	Quartz wool	6 g	402-825.044

Activated carbon for AOX analysis B1725



Halogen absorber filling for GL14 tube B1720



Quartz glass culet, coarse grains B1729



Special catalyst, platinum B1724



Special catalyst, platinum B1726



## Other consumables & parts

Part No	Description	Pack	Analytik Jena® part
E7100	Disposable retention filter (water trap)	1	402-881.228
E7125	Ferrule, 1/8"	1	402-880.352
E7121	Finger-tight-set, 1/16", for tube set, PEEK	1	402-881.027
E7124	Finger-tight-set, 1/8", for set of hoses	1	402-881.026
E7126	Male nut, 1/8"	1	402-880.353
E7103	Needles, 0.63 x 0.35 mm, all types of syringes	3	402-823.056
E7129	O-ring, 3.0 x 1.5 mm	10	402-815.030
E7130	O-ring for adaptor for drying tube, 32 x 3 mm	1	402-886.172
E7127	Polycarbonate membrane filter	100	402-815.035
E7115	Pump hose for peristaltic pump, waste	1	402-884.005
E7147	Removable needles for 50 and 100 µL syringes	3	402-823.079
E7142	Screw cap with hole, GL14	1	402-881.119, 402-889.305
E7143	Screw cap with hole, GL18	1	402-889.306
E7144	Seal for GL18 screw cap, sulfur coulometer	1	402-889.307
E7145	Seal for GL14 screw cap, sulfur coulometer	1	402-889.309
E7109	Septa for manual TIC port, 12.5 mm	5	402-889.050
E7138	Septa for titration cell, sulfur coulometer	50	402-889.314
E7101	TC pre-filter (aerosol trap)	1	402-881.229
E7102	TC pre-filter and water trap, set	1	402-881.245

E7102 set - comprises 1 each of:

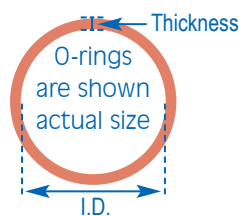
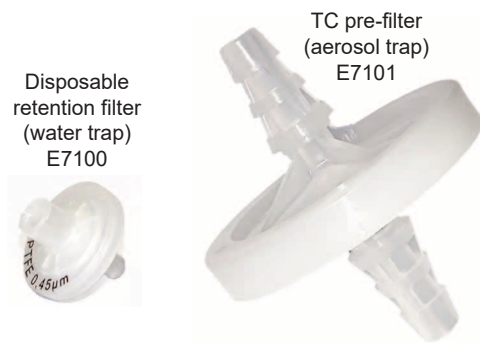

O-ring, 3.0 x 1.5 mm E7129



Seal for GL14 screw cap E7145



Seal for GL18 screw cap E7144



Septa for manual TIC port, 12.5 mm E7109



Removable needles for 50 and 100 µL syringes E7147

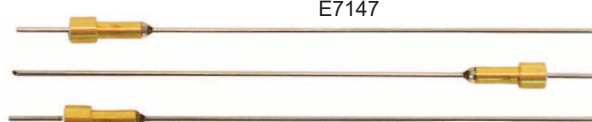



## Antek® MultiTek, 9000 Series & 7000 Series

### Quartz & glassware

Part No	Description	Pack	Antek® part
C3110	Pyrotube, direct inject	1	70061
C3111	Pyrotube, dual pass 9000 LLS	1	71303
C3112	Pyrotube, multi-matrix	1	71121
C3113	Pyrotube, multi-matrix	1	71127
C3122	Pyrotube, 90° elbow	1	70008
C3115	Quartz chips (pack = 1 fill)	67 g	71029



### Quartz boats for 9000/7000

Part No	Description	Pack	Antek® part
C3117	Sample boat, liquids, multi-matrix	1	71122
C3118	Sample boat, water jacket, Pyro	1	70007
C3116	Sample weigh boat carrier, multi-matrix	1	71124
C3119	Sample weigh boat, multi matrix	1	71123
C3121	Quartz weigh boat, solids	1	71039

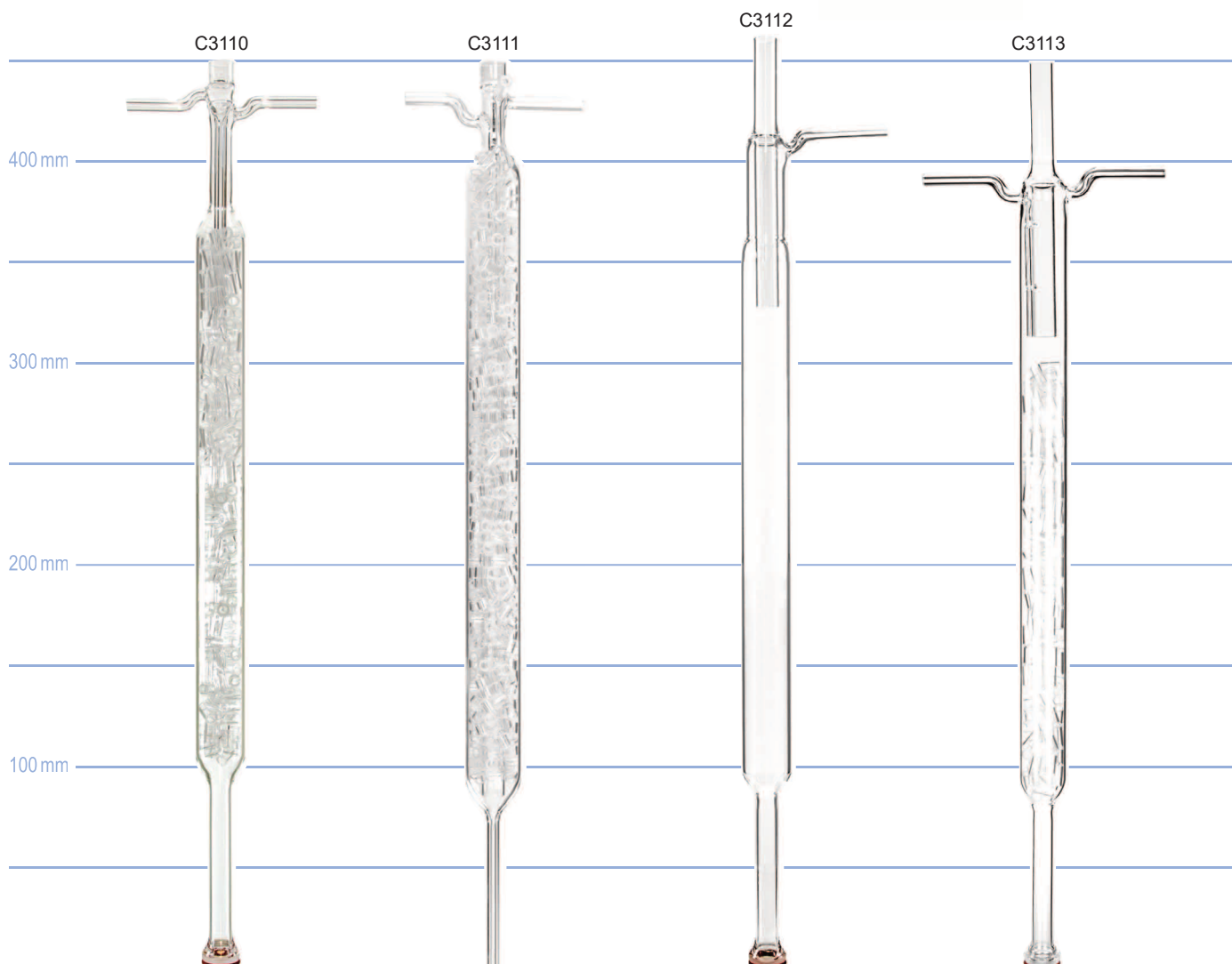

## Antek® MultiTek, 9000 Series & 7000 Series

### Other consumables & parts

Part No	Description	Pack	Antek® part
E7902	Cera-wool 2" x 2"	1	79127
B1715	Drierite, H <sub>2</sub> O removing	1lb	71028
E7901	Filter, parker	1	71111
E7910	Membrane dryer	1	70058
B1710	Moleculite, O <sub>3</sub> scrubber	1lb	72001
E1560	O-ring, tube inlet	1	71194
E1561	O-ring, tube exit	1	70256
E7900	Septum, 12.5 mm	10	70002
E7905	Septum, 12.5 mm	100	69091
E7906	Syringe, 100 µl	1	90073
E7907	Syringe, 25 µl, conetip	1	36117
E7908	Teflon ferrules, ¼"	3	70027
E7909	Teflon tubing, ½"	50 ft	30066



Moleculite  
B1710



Drierite  
B1715



Septum, 12.5 mm  
E7900, E7905



Cera-wool  
E7902



Parker filter  
E7901



Syringe, 100 µl  
E7906

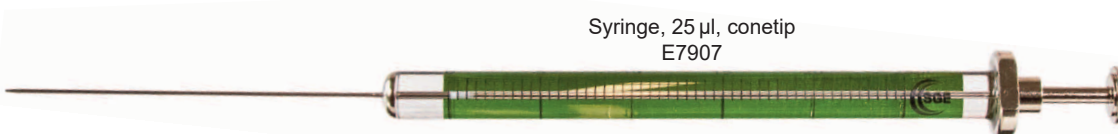

Syringe, 25 µl, conetip  
E7907



Teflon ferrules  
E7908

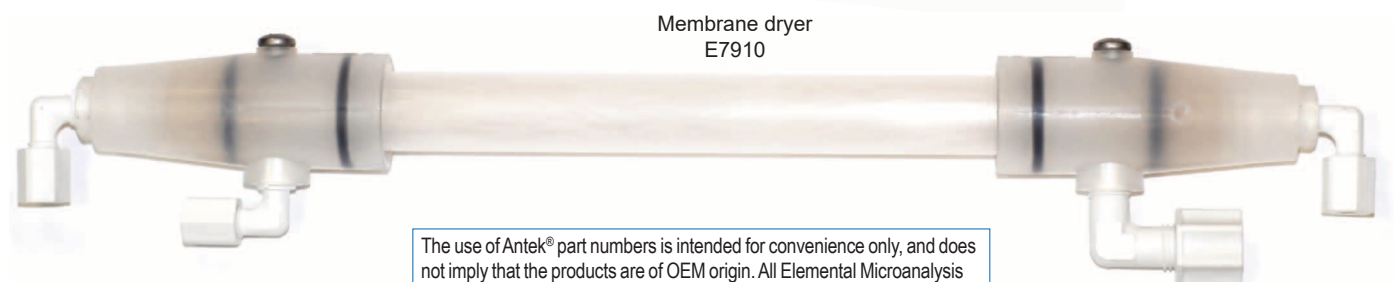

Membrane dryer  
E7910

The use of Antek® part numbers is intended for convenience only, and does not imply that the products are of OEM origin. All Elemental Microanalysis products are guaranteed to be of high quality and are deemed to be suitable alternatives in the stated instruments. All Antek® trademarks acknowledged.

## Metrohm® 930 Combustion IC (AJ furnace & ABD)

### Other consumables & parts

Part No	Description	Pack	Metrohm® part
C8134	Ceramic sample boat	10	
C5200	Quartz combustion tube	1	6.7301.000
C5201	Quartz hook for ABD	1	6.7301.110
C8133	Quartz sample boat 40 x 9 mm	10	6.7302.100

Ceramic sample boats C8134



Quartz hook for ABD C5201

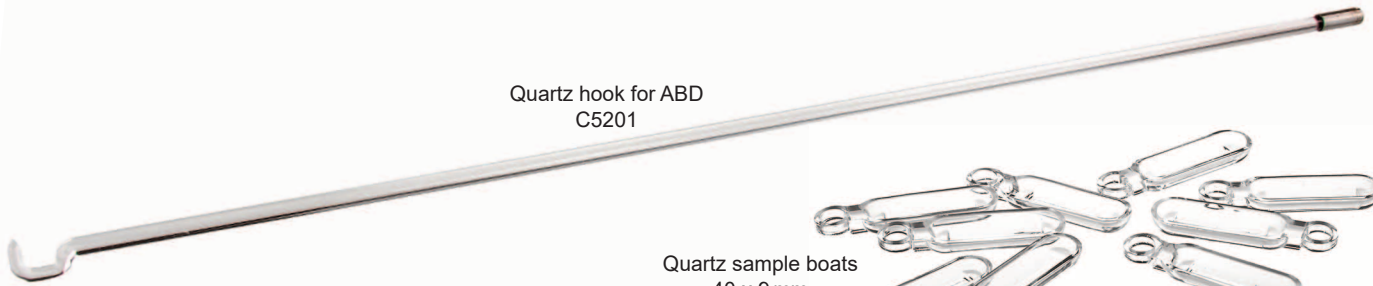

Quartz sample boats 40 x 9 mm C8133

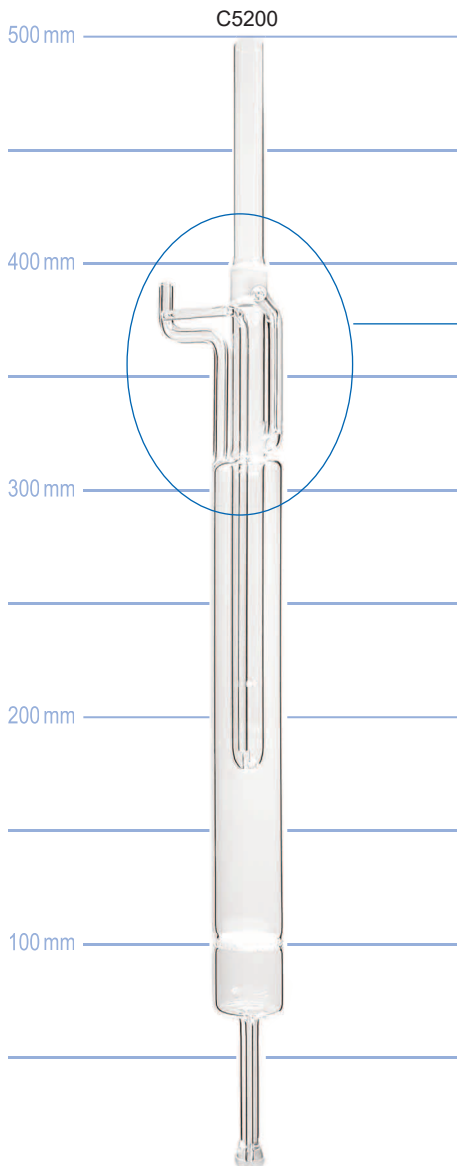

Closer view of inlet tubes and flame sensor, C5200

The use of Metrohm® part numbers is intended for convenience only, and does not imply that the products are of OEM origin. All Elemental Microanalysis products are guaranteed to be of high quality and are deemed to be suitable alternatives in the stated instruments. All Metrohm® trademarks acknowledged.



## Elementar® trace SN cube

### O-rings

Part No	Description (I.D. & thickness)	Pack	Elementar® part
E1054	Quadrang, 7.65 mm x 1.78 mm	1	200005999, 05 000 353
E1054-10	Quadrang, 7.65 mm x 1.78 mm	10	200005999, 05 000 353
E1067	O-ring, 4.5 mm x 1.5 mm	1	200008314, 05 000 249
E1067-10	O-ring, 4.5 mm x 1.5 mm	10	200008314, 05 000 249
E1073	O-ring, rubber, 20 mm x 2 mm	1	200007224, 03 654 627
E1073-10	O-ring, rubber, 20 mm x 2 mm	10	200007224, 03 654 627
E1075	O-ring, rubber, 24 mm x 2 mm	1	200007469, 03 002 267
E1075-10	O-ring, rubber, 24 mm x 2 mm	10	200007469, 03 002 267
E1173	O-ring, 5 mm x 1.5 mm		200006094, 05 000 425
E1178	O-ring, green, 6 mm x 3 mm	1	200013842, 05 001 076

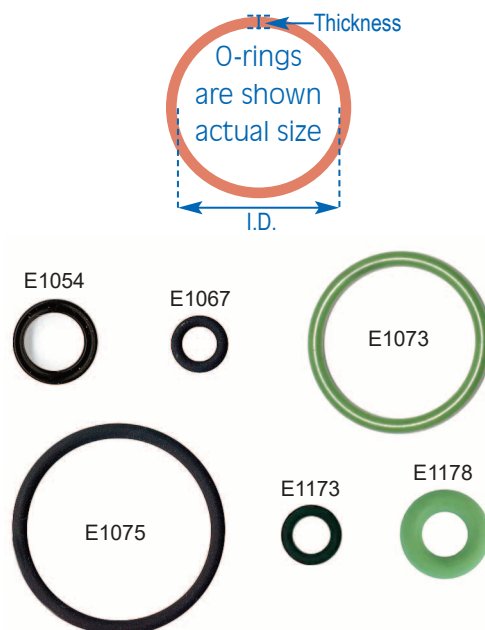

### Quartz & glassware

Part No	Description	Pack	Elementar® part
C3018	Ash finger, quartz, 60 mm	1	200014555, 11.00-1170/4
C3060	Ash finger, quartz, 60 mm, pack of 10	10	200014555, 11.00-1170/4
C3009	Combustion/reduction tube	1	200007844, 11.00-1150/4
C3021	Protection tube 105 mm	1	200014026, 11.00-1317/4
C3059	Protection tube 105 mm (alt to C3021 without slits)	1	200014026, 11.00-1317/4
C3017	Support tube 65 mm	1	200011820, 11.00-1172/4

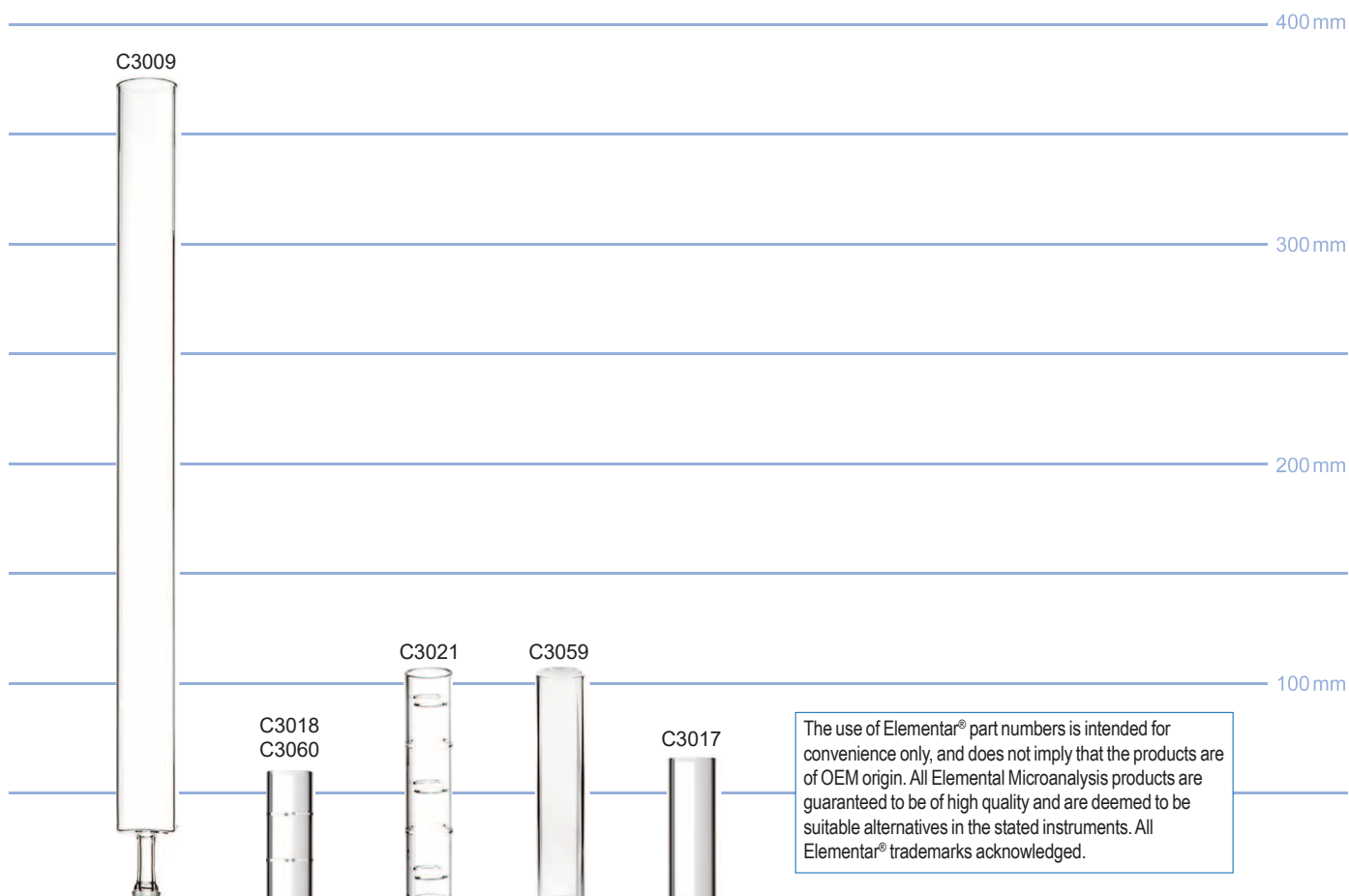

## Elementar® trace SN cube

### Reagents & fillings

Part No	Description	Pack	Elementar® part
B1657	Activated carbon	100 g	200015141, 11.21-0029
B1090	Alumina (aluminium oxide) spheres 3 to 6 mm	50 g	200010245, 50 008 467
B1270	Cerium dioxide, fused, granular	100 g	200013646, 05 000 469
B1218	Copper oxide wires (coarse), 6 x 0.65 mm	250 g	200007554, 03 679 905
 B1274	Magnesium perchlorate (flakes)	25 g	
B1196	Platinum catalyst, 5 % Pt	30 g	200007811, 03 002 262
B1308	Platinum catalyst, 5 % Pt	150 g	200007811, 03 002 262
B1215	Silica (quartz) chips, granular, 2 to 4 mm	50 g	200007521, 05 000 900
B1255	Silica (quartz) wool discs, 24 mm diameter	25	
B1208	Silica (quartz) wool, very fine	10 g	200004827, 03 679 908
B1217	Tungsten (VI) oxide granular	60 g	200008986, 11.02-0008

Activated carbon  
B1657



Cerium dioxide  
B1270



 These products are classified as hazardous for shipping

Silica (quartz) chips  
B1215

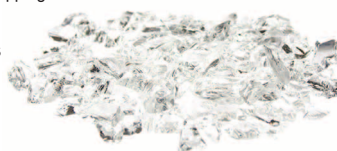

Platinum catalyst, 5% Pt  
B1196, B1308



### Operational accessories & tools

Part No	Description	Pack	Elementar® part
E2516	Cotton wool	50 g	200013169, 05 001 715
E1174	Filter, diameter 18 mm	1	200015256, 03 002 399
E1174-10	Filter, diameter 18 mm	10	200015256, 03 002 399
E2002	Macro multi-purpose spoon/spatula 215 mm		
E2526	Powder filling funnel (small) with silicone tubing outlet	1	200004594, 34.00-0051/4
E2532	Set of ball valve half shells 10 mm	1 set	200011004, 15.00-0005

Filter, diameter 18 mm  
E1174

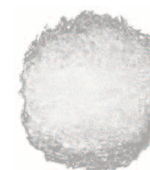

Multi-purpose  
spoon/spatula  
E2002

### Encapsulation

Part No	Description	Pack	Elementar® part
D4111	Aluminium capsules, smooth wall, flat base 7 x 2.7 mm	250	200005417, 05 000 814
D5132	Aluminium weighing boats 12 x 4 x 4 mm	1000	200013554, 03 674 012
D5133	Aluminium weighing boats 12 x 6 x 6 mm	500	200009311, 03 674 016
D4033	Smooth wall tin capsules, flat base 5.5 x 3.5 mm	100	200013224, 05 001 727
D4131	Smooth wall tin capsules, flat base 6 x 3 mm	250	200014058, 03 951 620
D4132	Smooth wall tin capsules, flat base 9 x 3.5 mm	250	200015479, 03 951 619
D4121	Smooth wall tin capsules, flat base 11 x 4.75 mm	250	200008184, 05 000 481
D4120	Smooth wall tin capsules, flat base 14 x 6.75 mm	100	200013285, 05 000 312
D5029	Tin boats 6 x 4 x 4 mm	1000	200007543, 11.02-1047
D5130	Tin boats 12 x 4 x 4 mm	1000	200014577, 22 137 418
D5131	Tin boats 12 x 6 x 6 mm	500	200007074, 22 137 419
D5032	Tin boats 15 x 8 x 8 mm	250	200012350, 22 137 420
D5140	Tin boats, heavy weight 12 x 4 x 4 mm	1000	200007257, 11.00-5057
D9001	Tin foil cones, standard weight	100	200009010, 05 000 429
D9010	Tin foil cones, standard weight	1500	200009795, 05 002 797
D1116	Tin foil squares, standard weight 37 x 37 mm	400	200005722, 12.01-0032
D1115	Tin foil squares, standard weight 50 x 50 mm	100	200011221, 12.01-0033
D1118	Tin foil squares, standard weight 50 x 50 mm	500	200011221, 12.01-0033

Tin boats 15 x 8 x 8 mm  
D5032

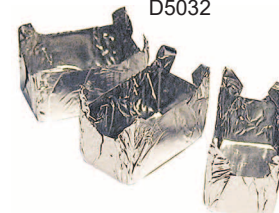

Tin foil cone  
D9001

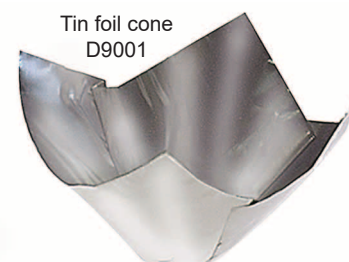

## Reference materials for TOC analysis

Analysis values may change depending on the current batch available; please see the website to view certificates of analysis, or contact our Sales Team for information on the current analysis values of reference materials.



### Soil and sediment standards

Part No	Description	Pack	<i>(Bracketed values are not certified and are for reference only)</i>				
			%C	%N	%S	%TIC	%TOC
B2150	Sediment standard high organic content	30g	7.45	0.52	0.62		
B2196	Set of 7 soil standards - contains 1 of each of the following B2176, B2180, B2182, B2184, B2188, B2189, B2237						
B2188	Soil standard (chalky)	30g	3.98	0.26		(0.83)	(3.15)
B2184	Soil standard (clay)	30g	2.31	0.23	(0.030)	(0.34)	(1.97)
B2189	Soil standard (mineral)	30g	0.34	0.029			
B2176	Soil standard (peaty)	30g	15.52	1.24	0.44	(0.30)	(15.22)
B2180	Soil standard (sandy)	30g	0.46	0.043		(0.09)	(0.37)
B2182	Soil standard (silty)	30g	2.16	0.182	(0.025)	(0.29)	(1.87)
B2152	Soil standard low organic content	30g	1.54	0.129	0.028		
B2230	Synthetic soil (high organic content)	30g	7.48	0.53	0.061	(0.32)	(7.16)
B2237	Synthetic soil (loamy)	30g	2.75	0.26	(0.068)	(0.16)	(2.59)
B2231	Synthetic soil (low organic content)	30g	1.42	0.100	0.032	(0.13)	(1.29)
B2233	Synthetic soil (medium organic content)	30g	2.49	0.16	0.037	(0.15)	(2.34)

### TOC/ROC/TIC standards

Part No	Description	Pack	%TOC	%ROC	%TIC	%TC (sum)
B2290	TOC/ROC/TIC silty soil standard	30g	1.49	0.44	0.27	2.19
B2292	TOC/ROC/TIC chalky soil standard	30g	2.71	0.51	1.34	4.56
B2293	TOC/ROC/TIC control standard to DIN19539	30g	2.24	1.69	1.93	5.85
B2294	TOC/ROC/TIC incinerator ash standard	30g	LOQ*	0.79	0.28	1.10
B2295	TOC/ROC/TIC foundry sand standard	30g	1.15	1.81	0.10	3.12

\* Limit of quantification (<0.1%)

Elemental Microanalysis offers a comprehensive range of reference materials, covering all areas of analysis.

Also available:

- Natural reference materials.
- IRMS standards.
- Coal and coke standards – green petroleum cokes, proximate coals, ultimate coals, as well as sulfur-only coals and cokes.
- Oil and fuel standards – residual oils, diesel oils, crude oils, lube oils, and biomass fuels.
- Inorganic standards – steel, titanium, and copper pin standards, cast iron standards, and ores.

For information on these other ranges see our website, or our specialist catalogues covering other areas of analysis.





Analytik Jena® multi EA 4000, multi N/C 3100 (duo, pharma), multi N/C 2100S (duo, pharma)

Quartz, furnace tubes & glassware

Part No	Description	Pack	Analytik Jena® part
C8130	Ceramic tube	1	402-886.014
C3201	Combustion tube	1	402-885.010
C3202	Combustion tube, outer diameter 16 mm	1	402-890.134
C3211	Drying tube with GL45 (without connectors)	1	402-886.129
C3215	Glass tube with thread, straight, (without connectors)	1	402-881.203
C3204	U-tube, OD 11 mm, without filling for halogen absorber	1	402-825.150
C3205	U-tube, OD 21 mm for halogen absorber (without connections)	1	402-881.013

Prepacked tubes

Part No	Description	Pack	Analytik Jena® part
X4020	Halogen absorber, complete with U-tube, 11 mm	1	402-885.019
X4021	Halogen absorber, complete with U-tube, 21 mm	1	402-886.313

The use of Analytik Jena® part numbers is intended for convenience only, and does not imply that the products are of OEM origin. All Elemental Microanalysis products are guaranteed to be of high quality and are deemed to be suitable alternatives in the stated instruments. All Analytik Jena® trademarks acknowledged.

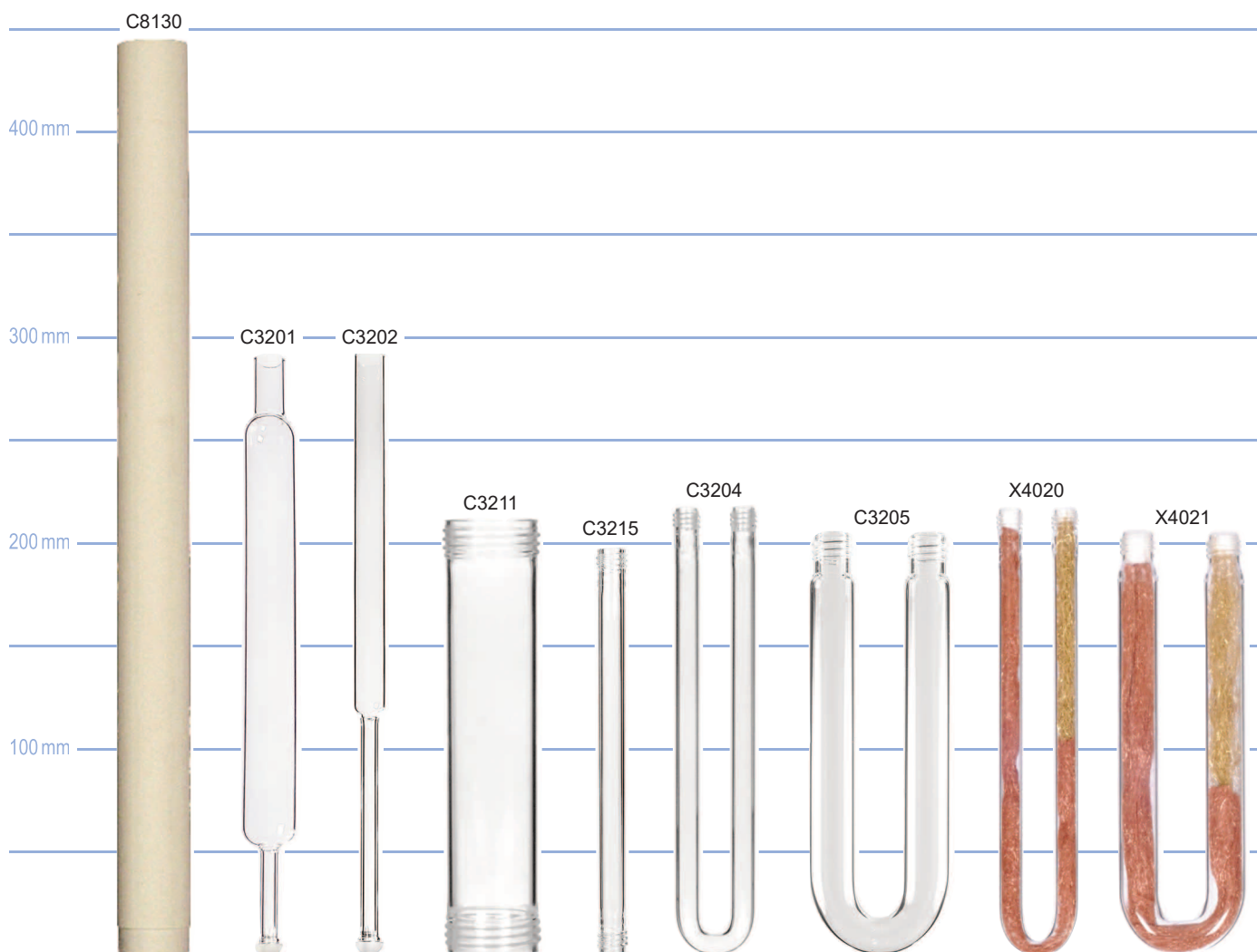

# Analytik Jena® multi EA 4000, multi N/C 3100 (duo, pharma), multi N/C 2100S (duo, pharma)

## Reagents and tube packings

Part No	Description	Pack	Analytik Jena® part
B1727	Calcium carbonate standard	100 g	402-886.131
B1161	EMADrone, magnesium perchlorate	454 g	402-886.116
B1720	Halogen absorber filling for GL14 U-tube	1 set	402-810.050
B1721	Halogen absorber filling for GL18 U-tube	1 set	402-886.312
B1722	Halogen absorber filling for GL18 U-tube	5 sets	402-886.322
B1723	Halogen absorber filling for straight tube	1 set	402-886.114
B1257	High-temperature mat	6	402-885.017
E7149	Platinum net	1	402-886.333
B1729	Quartz glass cullet, coarse grains	80 g	402-881.006
B1460	Quartz wool	6 g	402-825.044
B1731	Special catalyst multi N/C, CeO <sub>2</sub>	40 g	402-810.047
B1730	Special catalyst multi N/C, CeO <sub>2</sub>	200 g	402-810.058
B1724	Special catalyst, platinum	20 g	402-810.048
B1726	Special catalyst, platinum	~80 ml	402-810.059

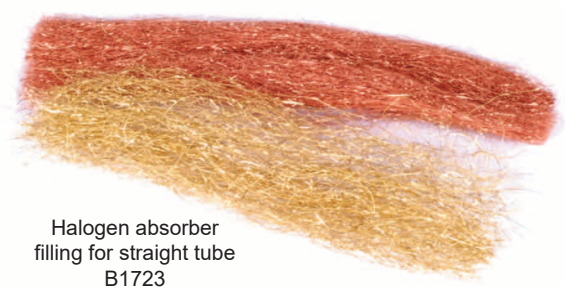

Halogen absorber filling for straight tube B1723



High-temperature mat B1257



Special catalyst CeO<sub>2</sub> B1730, B1731

These products are classified as hazardous for shipping

Platinum net E7149



Quartz glass cullet B1729

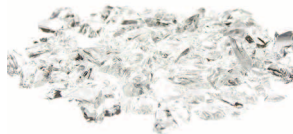

## Other consumables & parts

Part No	Description	Pack	Analytik Jena® part
E7119	Connector TC vessel	3	402-950.017
E7100	Disposable retention filter (water trap)	1	402-881.228
E7125	Ferrule, 1/8"	1	402-880.352
E7121	Finger-tight-set, 1/16", for tube set, PEEK	1	402-881.027
E7124	Finger-tight-set, 1/8", for set of hoses	1	402-881.026
E7135	Fork-type clamp KS 13/2 with clamping screw	1	402-825.041
E7132	Gasket for oxygen lock CS (34 x 3 mm)	1	402-886.010
E7111	Headline disposable in-line filter	10	402-881.213
E7118	IC condensing vessel, multi N/C 2100S	1	402-890.150
E7126	Male nut, 1/8"	1	402-880.353
E7103	Needles, 0.63 x 0.35 mm, all types of syringes	3	402-823.056
E7130	O-ring for adaptor for drying tube, 32 x 3 mm	1	402-886.172
E7116	Pump hose for peristaltic pump (acid)	1	402-885.011
E7115	Pump hose for peristaltic pump, waste	1	402-884.005
E7147	Removable needles for 50 and 100 µl syringes	3	402-823.079
E7142	Screw cap with hole, GL14	1	402-889.305
E7143	Screw cap with hole, GL18	1	402-889.306
E7144	Seal for GL18 screw cap, sulfur coulometer	1	402-889.307
E7145	Seal for GL14 screw cap, sulfur coulometer	1	402-889.309
E7110	Sealing ring, dust trap for HT oven, 34 x 4 mm	1	402-815.830
E7120	Sealing ring for lock, 30 x 5 mm	1	402-888.007
E7109	Septa for manual TIC port, 12.5 mm	5	402-889.050
E7104	Septa for pneumatic heads, 10 mm OD	10	402-881.238
E7138	Septa for titration cell, sulfur coulometer	50	402-889.314
E7108	Septa, uncut, for septum-head, 17 mm	3	402-886.326
E7107	Septum for syringe (autosampler), 9.5 mm OD	1	402-886.310
E7105	Syringe 250 µl with vent & removable needle (for APG 60)	1	402-886.304
E7106	Syringe 500 µl with vent & removable needle (for APG 60)	1	402-886.305
E7117	Syringe for Cavro syringe pump 5 ml	1	402-823.110
E7101	TC pre-filter (aerosol trap)	1	402-881.229
E7102	TC pre-filter and water trap, set	1	402-881.245

Headline disposable in-line filter E7111



Syringe 250 µl with vent and removable needle E7105



Syringe 500 µl with vent and removable needle E7106



Syringe for Cavro syringe pump 5 ml E7117



# Elementar® enviro TOC, vario TOC cube, vario TOC select

## O-rings

Part No	Description	Pack	Elementar® part
E1054	Quadring, 7.65 mm x 1.78 mm	1	200005999, 05 000 353
E1054-10	Quadring, 7.65 mm x 1.78 mm	10	200005999, 05 000 353
E1067	O-ring, 4.5 mm x 1.5 mm	1	200008314, 05 000 249
E1067-10	O-ring, 4.5 mm x 1.5 mm	10	200008314, 05 000 249
E1069	O-ring, 7.5 mm x 2.5 mm	1	200006004, 05 000 416
E1069-10	O-ring, 7.5 mm x 2.5 mm	10	200006004, 05 000 416
E1072	O-ring, 18 mm x 2 mm	1	200013028, 05 000 096
E1073	O-ring, rubber, 20 mm x 2 mm	1	200007224, 03 654 627
E1073-10	O-ring, rubber, 20 mm x 2 mm	10	200007224, 03 654 627
E1075	O-ring, rubber, 24 mm x 2 mm	1	200007469, 03 002 267
E1075-10	O-ring, rubber, 24 mm x 2 mm	10	200007469, 03 002 267
E1087	O-ring, black, 7.59 mm x 2.62 mm	1	200014191, 05 001 302
E1172	O-ring, 32 mm x 3 mm	1	200008068, 03 002 268
E1556	O-ring, 18 mm x 2.5 mm	1	200004884, 05 001 053

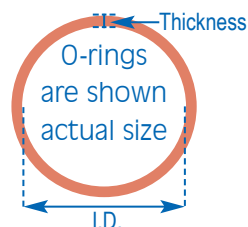

## Quartz & glassware

Part No	Description	Pack	Elementar® part
C3054	Ash crucible, quartz, 60 mm	1	200014796, 38.00-1290
C3018	Ash finger, quartz, 60 mm	1	200014555, 11.00-1170/4
C3060	Ash finger, quartz, 60 mm, pack of 10	10	200014555, 11.00-1170/4
C3009	Combustion/reduction tube	1	200007844, 11.00-1150/4
C1143	Drying tube 300 mm (tube only, no caps)	1	200008714, 15.00-0080
C3026	Drying tube 348 mm (with GL25 caps)	1	200011489, 16.00-1012
C3045	Filter tube	1	200013470, 50 009 375/4
C3074	Filter tube 42 mm	1	200007012, 16.00-1081
C3021	Protection tube 105 mm	1	200014026, 11.00-1317/4
C3059	Protection tube 105 mm (alt to C3021 without slits)	1	200014026, 11.00-1317/4

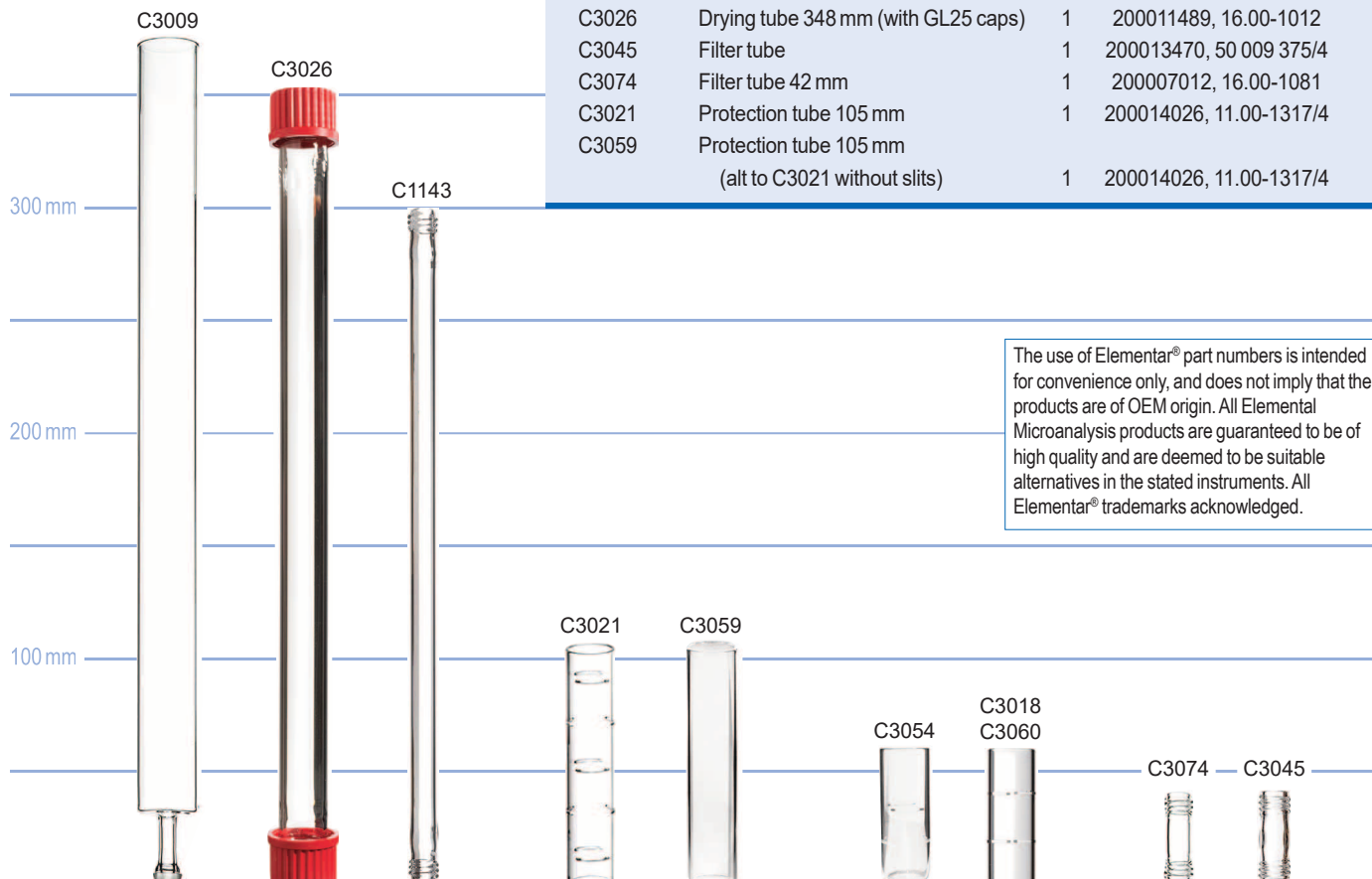

The use of Elementar® part numbers is intended for convenience only, and does not imply that the products are of OEM origin. All Elemental Microanalysis products are guaranteed to be of high quality and are deemed to be suitable alternatives in the stated instruments. All Elementar® trademarks acknowledged.



## Elementar® enviro TOC, vario TOC cube, vario TOC select

### Reagents

Part No	Description	Pack	Elementar® part
B1089	Alumina (aluminium oxide) wool, fine	20 g	200004773, 50 000 086
B1354	Aquatak (drying agent) without indicator	50 g	200008689, 05 002 799
B1304	Brass wool	50 g	200010160, 38.00-0124
B1270	Cerium dioxide, fused, granular	100 g	200013646, 05 000 469
B1218	Copper oxide wires (coarse), 6 x 0.65 mm	250 g	200007554, 03 679 905
B1122	Copper oxide wires (fine), 4 x 0.5 mm	250 g	200009554, 05 001 039
◆ B1141	Magnesium perchlorate, self indicating, granular, 0.7 to 1.2 mm	100 g	200006776, 05 001 059
B1196	Platinum catalyst, 5% Pt	30 g	200007811, 03 002 262
B1308	Platinum catalyst, 5% Pt	150 g	200007811, 03 002 262
B1601	Potassium hydrogen phthalate	25 g	200009208, 35.00-0151
B1255	Quartz wool discs, 24 mm diameter	25	
B1215	Silica (quartz) chips, granular, 2 to 4 mm	50 g	200007521, 05 000 900
B1208	Silica (quartz) wool, very fine	10 g	200004827, 03 679 908
B1231	Silver wool, 0.05 mm fine wire	50 g	200005872, 22 131 365
B1602	Sodium carbonate	25 g	200007465, 35.00-0152

◆ These products are classified as hazardous for shipping

Brass wool  
B1304



Cerium dioxide, fused, granular  
B1270



Platinum catalyst, 5% Pt  
B1196, B1308



### Operating supplies

Part No	Description	Pack	Elementar® part
E1174	Filter, diameter 18 mm	1	200015256, 03 002 399
E1174-10	Filter, diameter 18 mm	10	200015256, 03 002 399
E2533	Set of ball valve half shells 14 mm	1	200010811, 21.00-0008

Filter, diameter 18 mm  
E1174

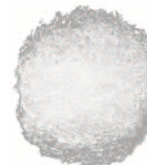

Set of ball valve half shells, 14 mm  
E2533



### Accessories

Part No	Description	Pack	Elementar® part
E2516	Cotton wool	50 g	200013169, 05 001 715
E2016	Forceps, stainless steel, curved points - length 130 mm	1	200010676, 03 001 248
E2538	GL14 blanking cap, red	2	
E2518	GL18 screw cap	1	200011744, 05 000 044
E2505	Gloves	Pair	200006785, 05 000 094
E2002	Macro multi-purpose spoon/spatula 215 mm	1	
E2521	Manually operated drill	1	200009657, 11.00-0500/4
E2064	Multiwell plate, 24 cell, flat bottom	1	200013850, 05 000 308
E2526	Powder filling funnel (small) with silicone tubing outlet	1	200004594, 34.00-0051/4
E2240	Vacuum grease	50 g	200006998, 03 968 006

GL18 screw cap  
E2518



GL14 blanking cap  
E2538



The use of Elementar® part numbers is intended for convenience only, and does not imply that the products are of OEM origin. All Elemental Microanalysis products are guaranteed to be of high quality and are deemed to be suitable alternatives in the stated instruments. All Elementar® trademarks acknowledged.

## Elementar® vario TOC cube, vario TOC select

### Sample encapsulation

Part No	Description	Pack	Elementar® part
D2008	Silver capsules pressed 8 x 5 mm	250	200014521, 05 001 540
D4103	Silver capsules smooth wall 5 x 2 mm	250	200013710, 24 005 100
D4102	Silver capsules smooth wall 5.5 x 3.5 mm	250	200007516, 05 000 816
D4109	Silver capsules smooth wall 9 x 3.5 mm	250	200010387, 05 000 817
D5127	Silver weighing boats 6 x 4 x 4 mm	500	200008833, 11.02-1046
D5039	Silver weighing boats 12 x 4 x 4 mm	500	200013336, 11.00-1371
D5026	Silver weighing boats 12 x 6 x 6 mm	100	200007754, 22 133 212
D5034	Silver weighing boats 15 x 8 x 8 mm	70	200013395, 22 133 213
D5035	Silver weighing boats 20 x 10 x 9 mm	42	200010913, 22 133 214
D4033	Smooth wall tin capsules flat base 5.5 x 3.5 mm	100	200013224, 05 001 727
D4131	Smooth wall tin capsules flat base 6 x 3 mm	250	200014058, 03 951 620
D4132	Smooth wall tin capsules flat base 9 x 3.5 mm	250	200015479, 03 951 619
D4121	Smooth wall tin capsules flat base 11 x 4.75 mm	250	200008184, 05 000 481
D4120	Smooth wall tin capsules flat base 14 x 6.75 mm	100	200013285, 05 000 312
D4009	Smooth wall tin capsules round base 20 x 8 mm	100	200011997, 05 000 311
D5029	Tin boats 6 x 4 x 4 mm	1000	200007543, 11.02-1047
D5130	Tin boats 12 x 4 x 4 mm	1000	200014577, 22 137 418
D5131	Tin boats 12 x 6 x 6 mm	500	200007074, 22 137 419
D5032	Tin boats 15 x 8 x 8 mm	250	200012350, 22 137 420
D5033	Tin boats 20 x 10 x 9 mm	120	200006296, 12.00-1009
D5140	Tin boats heavy weight 12 x 4 x 4 mm	1000	200007257, 11.00-5057
D9001	Tin foil cones standard weight	100	200009010, 05 000 429
D1068	Tin foil squares standard weight 37 x 37 mm	100	200009010, 05 000 429
D1118	Tin foil squares standard weight 50 x 50 mm	500	200011221, 12.01-0033
D1119	Tin foil squares standard weight 50 x 50 mm	1500	200008484, 34.00-0052



D4109



D4033



D4121

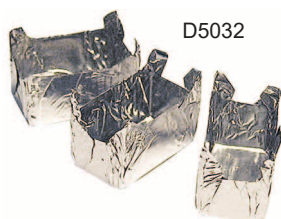

D5032

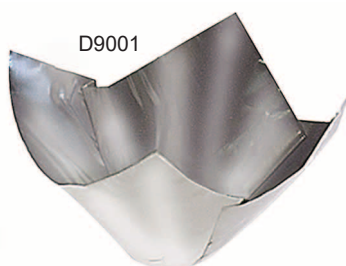

D9001



D4009

For additional encapsulation options, visit our website, [www.elementalmicroanalysis.com](http://www.elementalmicroanalysis.com) or view our capsules catalogue



D5033



D1068

## Elementar® soli TOC cube

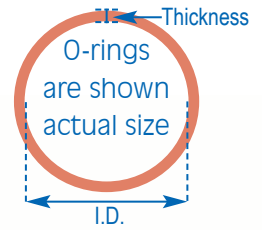
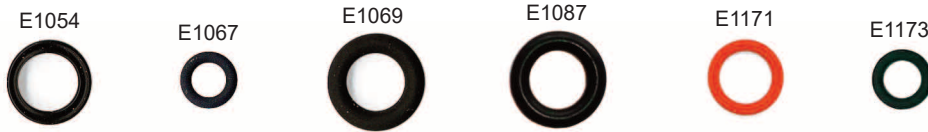

### O-rings

Part No	Description	Pack	Elementar® part
E1054	Quadrang, 7.65 mm x 1.78 mm	1	200005999, 05 000 353
E1054-10	Quadrang, 7.65 mm x 1.78 mm	10	200005999, 05 000 353
E1067	O-ring, 4.5 mm x 1.5 mm	1	200008314, 05 000 249
E1067-10	O-ring, 4.5 mm x 1.5 mm	10	200008314, 05 000 249
E1069	O-ring, 7.5 mm x 2.5 mm	1	200006004, 05 000 416
E1069-10	O-ring, 7.5 mm x 2.5 mm	10	200006004, 05 000 416
E1087	O-ring, black, 7.59 mm x 2.62 mm	1	200014191, 05 001 302
E1171	O-ring for gripper arm	1	200010589, 03 002 395
E1172	O-ring, 32 mm x 3 mm	1	200008068, 03 002 268
E1173	O-ring, 5 mm x 1.5 mm	1	200006094, 05 000 425
E1175	O-ring, 16 mm x 3 mm	1	200007904, 05 000 568
E1175-10	O-ring, 16 mm x 3 mm	10	200007904, 05 000 568
E1555	Shaft seal	1	200006143, 03 002 607



### Quartz & glassware

Part No	Description	Pack	Elementar® part
C3067	Combustion tube, quartz	1	200015419, 29.00-1078

### Reagents & fillings

Part No	Description	Pack	Elementar® part
B1090	Alumina (aluminium oxide) spheres 3 to 6 mm	50 g	200010245, 50 008 467
B1354	Aquatak (drying agent) without indicator	50 g	200008689, 05 002 799
B1304	Brass wool	50 g	200010160, 38.00-0124
E2516	Cotton wool	50 g	200013169, 05 001 715
◆ B1141	Magnesium perchlorate, self indicating, granular, 0.7 to 1.2 mm	100 g	200006776, 05 001 059
B1255	Quartz wool discs, 24 mm diameter	25	
B1208	Silica (quartz) wool, very fine	10 g	200004827, 03 679 908

◆ These products are classified as hazardous for shipping

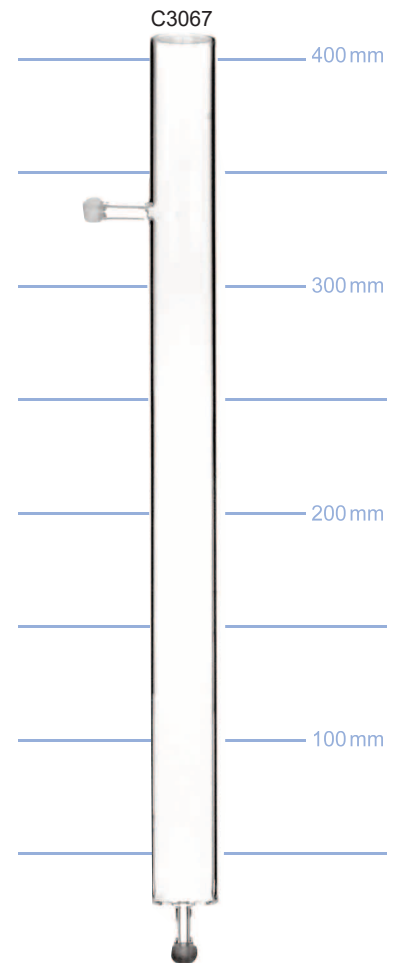
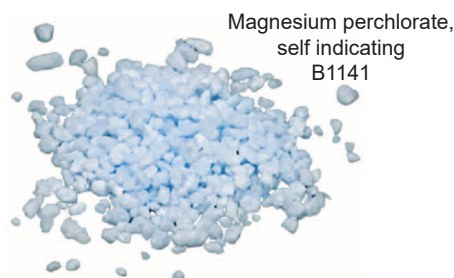

The use of Elementar® part numbers is intended for convenience only, and does not imply that the products are of OEM origin. All Elementar Microanalysis products are guaranteed to be of high quality and are deemed to be suitable alternatives in the stated instruments. All Elementar® trademarks acknowledged.



## Shimadzu® TOC-L, TOC-V, TOC-4110 series

### O-rings

Part No	Description	Pack	Shimadzu® part
E1550	O-ring 4D P10A	1	036-11352-86, 036-11209-84
E1551	O-ring 4D P22	1	036-11352-92, 036-11222-84
E1552	O-ring AS 568A-116	1	630-01566-00
E1553	O-ring Teflon P10	1	036-11408-84

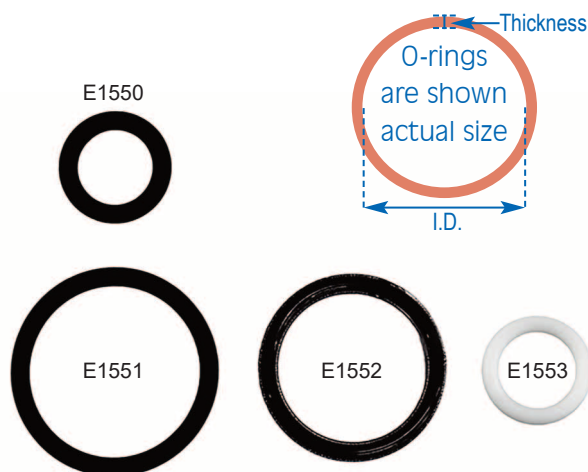

### Prepacked scrubbers

Part No	Description	Pack	Shimadzu® part
X4010	CO <sub>2</sub> scrubber	1	630-00999
X4000	Halogen scrubber	1	630-00992

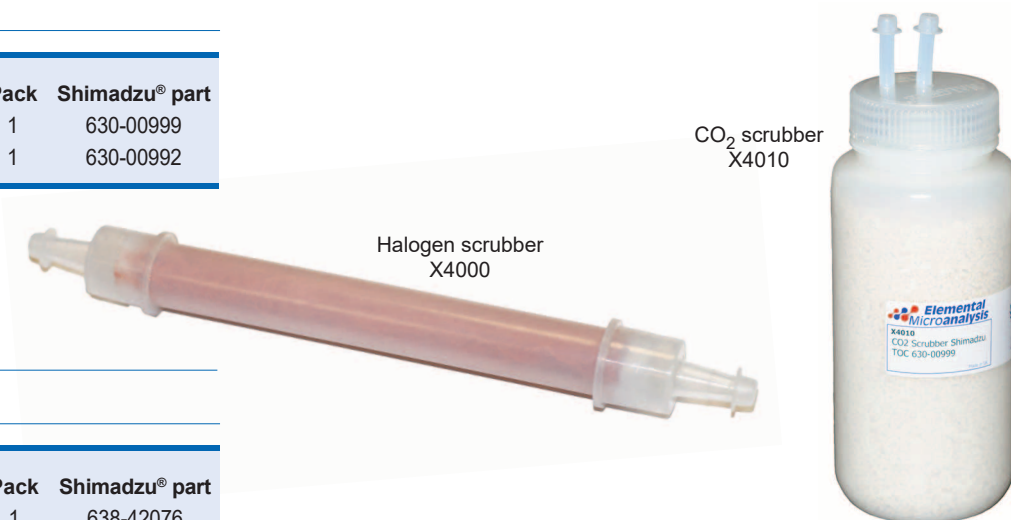

### Quartz & glassware

Part No	Description	Pack	Shimadzu® part
C8060	Combustion tube	1	638-42076
C8061	High salt combustion tube	1	631-41524

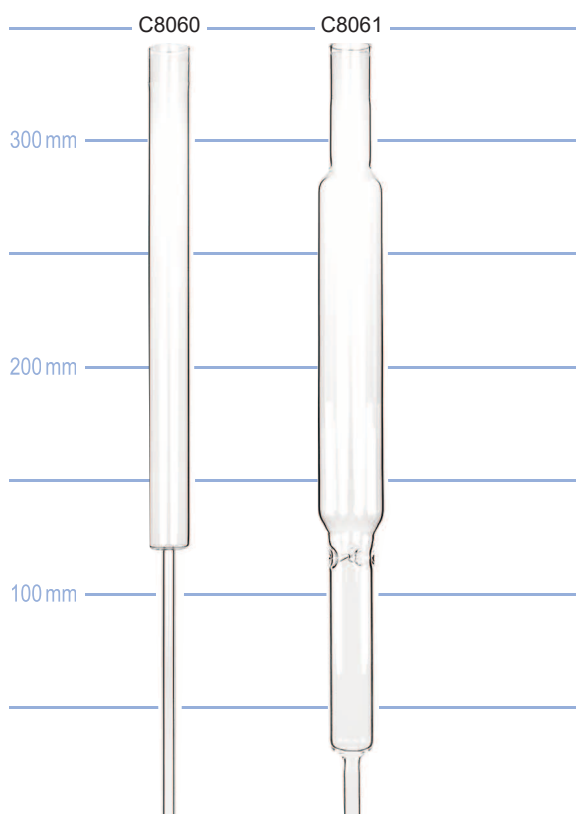

### Operating supplies

Part No	Description	Pack	Shimadzu® part
E7072	Chart paper 108 x 50 m	10	630-08913-01
E7070	5 ml sample vials, round bottom	100	
E7071	5 ml sample vials, round bottom, cap & seal	100	
E7054	5 ml syringe	1	638-59161-10
D7018	Platinum gauze discs	2	630-00105-01
E1554	Sleeve set 6F-T, front and back ferrule	1	035-62994-03
E7050	Syringe 250 µl	1	630-02591-04
E7051	Syringe 2500 µl	1	630-02591-07
E7052	Teflon syringe tips for 250 µl syringe	5	638-60734-05
E7053	Teflon syringe tips for 2500 µl syringe	3	638-60734-08



The use of Shimadzu® part numbers is intended for convenience only, and does not imply that the products are of OEM origin. All Elemental Microanalysis products are guaranteed to be of high quality and deemed to be suitable alternatives in the stated instruments. All Shimadzu® trademarks acknowledged.

## Shimadzu® TOC-L, TOC-V, TOC-4110 series

### Platinum catalysts for Shimadzu TOC

The in-house R&D team at Elemental Microanalysis has developed new platinum catalysts which are suitable for use in Shimadzu TOC-L and TOC-V analysers. These catalysts are intended as a direct replacement for the standard, or normal sensitivity, platinum catalysts that Shimadzu offers.

The catalysts from Elemental use a zirconia support, rather than alumina, hence there is a colour and weight difference when compared to the OEM catalysts. Our zirconia versions offer the following advantages over the OEM catalysts:

- lower blank values – leading to lower practical limit of quantification
- stabilises more quickly – allows faster conditioning of catalyst when installing a new reaction tube
- longer lifetime – allows greater number of sample runs before replacement
- more robust – less prone to physical degradation

Details of the new catalysts on offer, B1609, B1610 and B1611, are shown below.



Platinum Catalyst-ST for Shimadzu TOC, B1609

### Reagents

Part No	Description	Pack	Shimadzu® part
B1001	Cobaltous/ic oxide granular, 0.85 to 1.7 mm	25 g	638-60239-41, 630-00566
B1605	High sensitivity catalyst	2 g	630-00996
B1606	High sensitivity TC catalyst set		638-92070-01
B1600	IC reagent	250 ml	630-00710
B1609	Platinum catalyst-ST for Shimadzu TOC (Equivalent to 33 g of 638-60246)	117 g	638-60246
B1610	Platinum catalyst for Shimadzu TOC (Equivalent to 20 g of 638-60202-01)	71 g	638-60202-01
B1611	Platinum catalyst for Shimadzu TOC (Equivalent to 15 g of 638-60202-00)	54 g	638-60202-00
B1601	Potassium hydrogen phthalate	25 g	638-60241-41, 630-00635-01
B1255	Quartz wool discs, 24 mm diameter	25	
B1017	Silica (quartz) wool, very fine	5 g	630-00557
B1602	Sodium carbonate	25 g	638-60240-41, 630-00962-01
B1603	Sodium hydrogen carbonate	25 g	638-60242-41, 630-00963-01
B1607	TC catalyst set		638-92069-02

Cobaltous/ic oxide granular, 0.85 to 1.7 mm B1001



TC catalyst set B1607  
Contains 1 each of B1609 and D7018



These products are classified as hazardous for shipping

High sensitivity catalyst B1605





Sodium carbonate B1602



## Skalar® Primacs Series

### Capsules and reagents

Part No	Description	Pack	Skalar® part
B1315	Aluminium oxide carrier	50 g	2CA16353
D5013	Aluminium weighing pans pressed 7.5 x 15 mm	100	
 B1312	Anhydron - water absorber	200 g	2SN20354
B1313	Brass wool	100 g	90050628
B1608	Copper oxide wires (coarse) 6 x 0.65 mm	200 g	2SN20352
B1314	Copper reductor	350 g	2SN20357
 B1325	EMASorb II B granular, 8-20 mesh, CO <sub>2</sub> absorbant	200 g	2SN20355
B1141	Magnesium perchlorate, self indicating, granular 0.7 to 1.2 mm	100 g	
B1250	Quartz wool discs, 15 mm diameter	25	90035245
B1208	Silica (quartz) wool, very fine	10 g	2CA10359
B1170	Steel wool	100 g	90050629

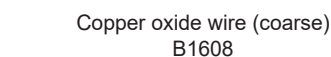
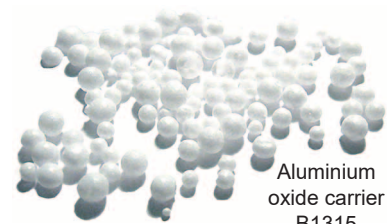

The use of Skalar® part numbers is intended for convenience only, and does not imply that the products are of OEM origin. All Elemental Microanalysis products are guaranteed to be of high quality and are deemed to be suitable alternatives in the stated instruments. All Skalar® trademarks acknowledged.

  These products are classified as hazardous for shipping

### Glassware

Part No	Description	Pack	Skalar® part
C8105	Brass scrubber tube, 220 mm, borosilicate	1	2SN100061
C8104	He ref. scrubber tube, 120 mm, borosilicate	1	2NC22141
C8101	Quartz tube, Cu reductor	1	2SN100099
C8102	Small scrubber tube, 220 mm, borosilicate	1	2SN100062
C8103	Large scrubber tube, 310 mm, borosilicate	1	2NC22140

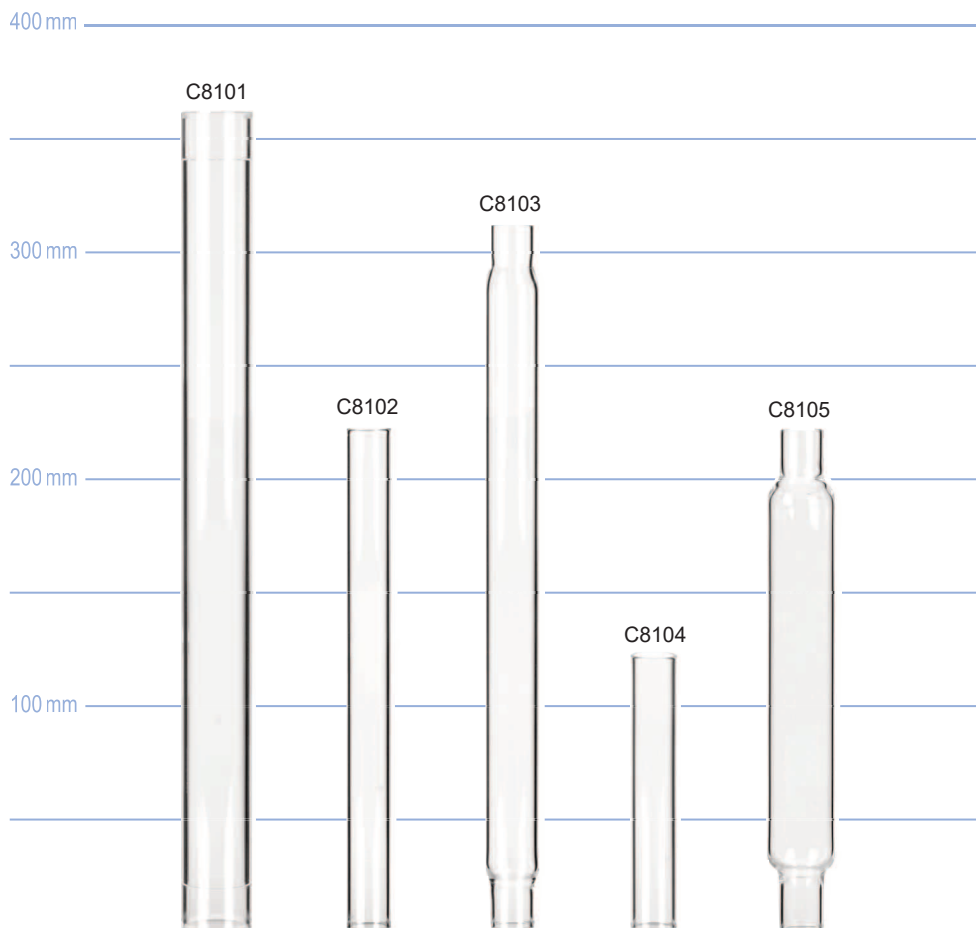



## Thermo Euroglas® TOC1200, ECS1200, TN3000, TS3000, ECS3000

### Quartz & glassware

Part No	Description	Pack	Thermo Euroglas® part
C5125	Boat guiding tube AOX	1	MODUL0009
C5103	Combustion tube universal model 3000	1	PANAL0125
C5112	Copper oxide scrubber	1	TOC120037
C5113	Glass connector outlet	1	PANAL0162
C5120	Glass part for liquids module, model MODUL0007	1	CASSE0002
C5121	Glass part for liquids module, model MODUL0019	1	CASSE0012
C5101	Quartz combustion tube universal	1	PANAL0065
C5110	Quartz sample boat Euroglas	1	PINJE0012
C5111	Quartz sample boat Euroglas	1	PINJE0018
C5114	Quartzfrit	3	PPTRE0047
C5115	Quartz combustion boat, solids	1	MODUL0004
C5116	Quartz combustion boat, AOX	1	MODUL0010
E7742	Quartz sample cup, AOX column method	1	PGLAS0032
C5100	Turbo tube model 3000	1	PANAL0126
C5102	Turbo combustion tube	1	PANAL0068
E7847	UV scrubber	1	TS3000003

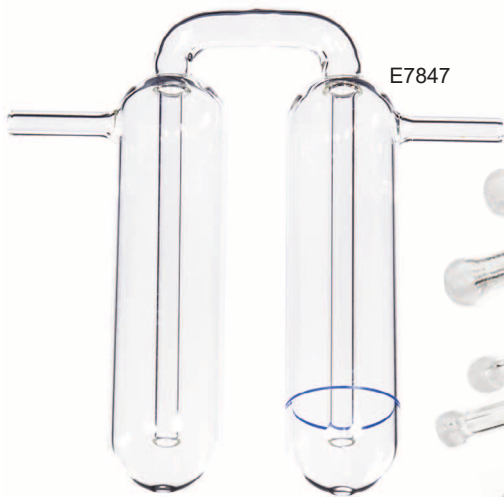

### Reagents

Part No	Description	Pack	Thermo Euroglas® part
B1653	Activated carbon AOX, batch PPTRE0049	50 g	PPTRE0049
E7737	Catalyst, Pt on ceramic base	100 g	PGENE0029
B1248	Copper oxide fine wires 4 x 0.5 mm	25 g	
B1651	Filled micro-columns	100	PPTRE0020
B1650	Potassium chloride 3M saturated with silver chloride	250 ml	PANAL0013
B1278	Quartz wool	10 g	PGLAS0077
B1665	Silver wool	10 g	PANAL0106



Potassium chloride 3M saturated with silver chloride B1650



Catalyst, Pt on ceramic base E7737



Silver wool B1665

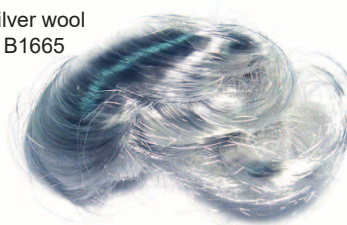

## Thermo Euroglas® TOC1200, ECS1200, TN3000, TS3000, ECS3000

### Operating parts & accessories

Part No	Description	Pack	Thermo Euroglas® part
E7792	1/4" OD PTFE tubing	1 m	PMECH0528
E7732	Cableset ECS 1200/3000	1	PELEC0371
E7712	Cathode, Pt	1	PANAL0092
E7704	Cathode platinum capillary cell	1	PANAL0051
E7602	Clear vial 2 ml 12 x 32 mm, screw thread	100	ELS200042
E7646	Connection furn scrub 3000	1	ECS300009
E7702	Electrode container capillary cell incl. o-ring	1	PANAL0047
E7500	Euroglas halogen reference electrode	1	PANAL0052
E7501	Euroglas generating electrode, Ag	1	PANAL0049
E7502	Euroglas measuring electrode, Ag	1	PANAL0050
E7696	Gas inlet 35 ml titration cell	1	PANAL0021
E7713	Gas outlet tube	1	PANAL0123
E7740	Glass fibre filters 5 µm	10	PGENE0052
E7701	Halogen titration cell - capillary	1	PANAL0046
E7837	In-line filter	1	TN3000030
E7738	Inner tube of permapure dryer only	1	PGENE0032
E7688	Liquid sample introduction module, 3000 series	1	MODUL0019
E7530	Needle, 71 mm, PS5 GA22	3	PGENE0004
E7850	Non return vessel TS	1	TS3000014
E7705	NOX scrubber	1	PANAL0056
E7715	Paper filter, TN only	10	PANAL0161
E7511	Perma Pure dryer	1	TN3000029
E7753	POX sample bottle 100 ml	1	PINJE0004
E7775	Quick connector female, blue (oxygen)	1	PMECH0154
E7776	Quick connector, male, blue (oxygen)	1	PMECH0155
E7777	Quick connector, male, white (argon)	1	PMECH0156
E7778	Quick connector, female, white (argon)	1	PMECH0157
E7764	Screwcap with bore GL-25 POX-B	1	PMECH0044
E7603	Septa, PTFE, 7.7 mm, silicone lined, for caps	100	ELS300006
E7505	Septum, 12.5 mm diameter	10	PANAL0025
E7604	Screw caps for vials	100	ELS200003
E7691	Stirrer bar for 35 ml cell	1	PANAL0005
E7541	Syringe, 100 µl, 71 mm, PS5 GA22	1	PGENE0002
E7726	Thermocouple 1200/3000 series	1	PELEC0132



Cathode platinum capillary cell  
E7704



Generating electrode Ag  
E7501

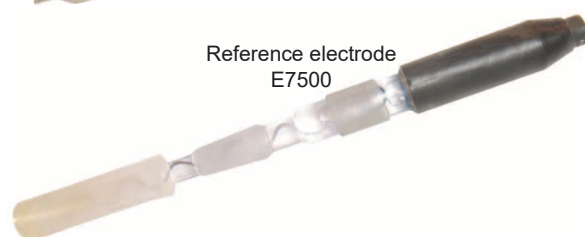

Reference electrode  
E7500

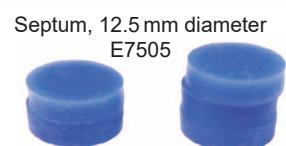

Septum, 12.5 mm diameter  
E7505



Syringe, 100 µl  
E7541

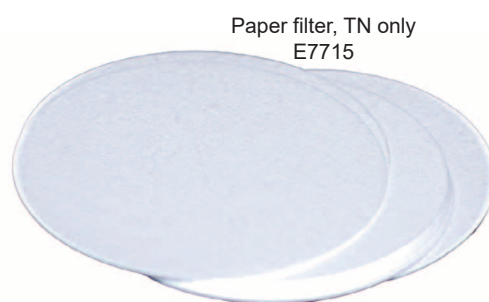

Paper filter, TN only  
E7715



Cableset ECS 1200/3000  
E7732



Quick connector male,  
blue (oxygen)  
E7776



Quick connector, female,  
white (argon)  
E7778



Glass fibre filters, 5 µm  
E7740

# Vials, caps & accessories for Dionex™ autosamplers AS40, AS50, AS-DV, AS-AP

## Vials, caps & accessories

Part No	Description	Pack	Dionex™ part			
F7009	0.5 ml vial (vial only)	250	038010		Cap (with filter) for 0.5 ml vials	Cap (without filter) for 0.5 ml vials
F7002	0.5 ml vial with cap (with filter)	250	038142			
F7003	0.5 ml vial with cap (without filter)	250				
F7010	Cap (with filter) for 0.5 ml vials	250	038011			
F7011	Cap (without filter) for 0.5 ml vials	250	042154, 079797			
F7005	5 ml vial (vial only)	250	038008		Cap (with filter) for 5 ml vials	Cap (without filter) for 5 ml vials
F7000	5 ml vial with cap (with filter)	250	038141			
F7001	5 ml vial with cap (without filter)	250	039532			
F7006	Cap (with filter) for 5 ml vials	250	038009			
F7007	Cap (without filter) for 5 ml vials	250	039528			
F7012	7 ml vial with pierce cap	250	055058		Insertion tool F7008	
F7004	Vial kit, 1.5 ml polypropylene, with caps and septa	100	061696, 079812			
F7008	Insertion tool					



The use of Dionex™ part numbers is intended for convenience only, and does not imply that the products are of OEM origin. All Elemental Microanalysis products are guaranteed to be of high quality and are deemed to be suitable alternatives in the stated instruments. All Dionex™ trademarks acknowledged.



# Analysis Service



Our analytical services cover a diverse range of sample types and applications, performed by a laboratory with over 45 years of accumulated analytical expertise.

Our UKAS accredited ISO 17025 Laboratory performs C H N O S and nitrogen/protein analysis, and offers specialized capability for air sensitive samples.\* We can also provide IC halogens analysis, organic TOC, inorganic analysis, micro-ashing, and a broad range of stable isotope analytical services.

- Rapid turnaround of results
- Expedited service also available
- UKAS accredited Testing Laboratory No. 4260

Whether you have a single sample, or an on-going research program, we offer you commitment to precision and accuracy at an affordable price.

visit our website for details or to submit a sample

[elementallab.co.uk](http://elementallab.co.uk)

\* see scope for full details



Call: +44 (0)1837 54446

Email: [enquiries@microanalysis.co.uk](mailto:enquiries@microanalysis.co.uk)

Technical queries: [analyst@microanalysis.co.uk](mailto:analyst@microanalysis.co.uk)

Visit: [elementallab.co.uk](http://elementallab.co.uk)

Follow: @ElementalLab

A DIVISION OF



Elemental Microanalysis holds the following certification and accreditation:



## Cross references TRACE & TOC analysis

### Analytik Jena®

Analytik Jena® Part	Description	Part No
402-810.004	Activated carbon for AOX analysis	B1725
402-810.047	Special catalyst multi N/C, CeO <sub>2</sub>	B1731
402-810.048	Special catalyst, platinum	B1724
402-810.050	Halogen absorber filling for GL14 tube (copper & brass wool)	B1720
402-810.058	Special catalyst multi N/C, CeO <sub>2</sub>	B1730
402-810.059	Special catalyst, platinum	B1726
402-815.030	O-ring, 3.0 x 1.5 mm	E7129
402-815.035	Polycarbonate membrane filter	E7127
402-815.830	Sealing ring, dust trap for HT oven, 34 x 4 mm	E7110
402-823.056	Needles, 0.63 x 0.35 mm, all types of syringes	E7103
402-823.079	Removable needles for 50 and 100 µL syringes	E7147
402-823.110	Syringe for Cavo syringe pump 5 ml	E7117
402-825.041	Fork-type clamp KS 13/2 with clamping screw	E7135
402-825.044	Quartz wool	B1460
402-825.150	U-tube, OD 11 mm, without filling for halogen absorber	C3204
402-880.352	Ferrule, 1/8 "	E7125
402-880.353	Male nut, 1/8 "	E7126
402-881.006	Quartz glass cullet, coarse grains	B1729
402-881.013	U-tube, OD 21 mm for halogen absorber	C3205
402-881.026	Finger-tight-set, 1/8 ", for set of hoses	E7124
402-881.027	Finger-tight-set, 1/16 ", for tube set, PEEK	E7121
402-881.119	Screw cap with hole, GL14	E7142
402-881.203	Glass tube with thread, straight, (without connectors)	C3215
402-881.213	Headline disposable in-line filter	E7111
402-881.228	Disposable retention filter (water trap)	E7100
402-881.229	TC pre-filter (aerosol trap)	E7101
402-881.238	Septa for pneumatic heads, 10 mm OD	E7104
402-881.245	TC pre-filter and water trap, set	E7102
402-884.005	Pump hose for peristaltic pump, waste	E7115
402-885.010	Combustion tube	C3201
402-885.011	Pump hose for peristaltic pump (acid)	E7116
402-885.017	High-temperature mat	B1257
402-885.019	Halogen absorber, complete with U-tube, 11 mm	X4020
402-886.010	Gasket for oxygen lock CS (34 x 3 mm)	E7132
402-886.014	Ceramic tube	C8130
402-886.114	Halogen absorber filling for straight tube	B1723
402-886.116	EMADrone, magnesium perchlorate	B1161
402-886.129	Drying tube with GL45 (without connectors)	C3211
402-886.131	Calcium carbonate standard	B1727
402-886.172	O-ring for adaptor for drying tube, 32 x 3 mm	E7130
402-886.304	Syringe 250 µl with vent & removable needle (for APG 60)	E7105
402-886.305	Syringe 500 µl with vent & removable needle (for APG 60)	E7106
402-886.310	Septum for syringe (autosampler), 9.5 mm OD	E7107
402-886.312	Halogen absorber filling for GL18 U-tube	B1721
402-886.313	Halogen absorber, complete with U-tube, 21 mm	X4021
402-886.322	Halogen absorber filling for GL18 U-tube	B1722
402-886.326	Septa, uncut, for septum-head, 17 mm	E7108
402-886.333	Platinum net	E7149
402-888.007	Sealing ring for lock, 30 x 5 mm	E7120
402-889.050	Septa for manual TIC port, 12.5 mm	E7109
402-889.066	Quartz hook for ABD	C5201
402-889.305	Screw cap with hole, GL14	E7142
402-889.306	Screw cap with hole, GL18	E7143
402-889.307	Seal for GL18 screw cap, sulfur coulometer	E7144

The use of OEM part numbers is intended for convenience only, and does not imply that the products are of OEM origin. All Elemental Microanalysis products are guaranteed to be of high quality and are deemed to be suitable alternatives.

Analytik Jena® Part	Description	Part No
402-889.309	Seal for GL14 screw cap, sulfur coulometer	E7145
402-889.314	Septa for titration cell, sulfur coulometer	E7138
402-889.510	Multi-purpose combustion tube	C3214
402-889.674	Quartz sample boat 40 x 9 mm	C8133
402-890.134	Combustion tube, outer diameter 16 mm	C3202
402-890.150	IC condensing vessel, multi N/C 2100S	E7118
402-899.673	Quartz sample boats with downholder 40 x 9 mm	C8135
402-950.017	Connector TC vessel	E7119

### Antek®

Antek® Part	Description	Part No
30066	Teflon tubing, 1/8 "	E7909
36117	Syringe, 25 µl, conetip	E7907
69091	Septum, 12.5 mm	E7905
70002	Septum, 12.5 mm	E7900
70007	Sample boat, water jacket, Pyro	C3118
70008	Pyrotube, 90° elbow	C3122
70027	Teflon ferrules, 1/4 "	E7908
70058	Membrane dryer	E7910
70061	Pyrotube, direct inject	C3110
70256	O-ring, tube exit	E1561
71028	Drierite, H <sub>2</sub> O removing	B1715
71029	Quartz chips (pack = 1 fill)	C3115
71039	Quartz weigh boat, solids	C3121
71111	Filter, parker	E7901
71121	Pyrotube, multi-matrix	C3112
71122	Sample boat, liquids, multi-matrix,	C3117
71123	Sample weigh boat, multi matrix	C3119
71124	Sample weigh boat carrier, multi-matrix	C3116
71127	Pyrotube, multi-matrix	C3113
71194	O-ring, tube inlet	E1560
71303	Pyrotube, dual pass 9000 LLS	C3111
72001	Moleculite, O <sub>3</sub> scrubber	B1710
79127	Cera-wool 2 " x 2 "	E7902
90073	Syringe, 100 µl	E7906

### Elementar®

Elementar® Part	Description	Part No
200004594	Powder filling funnel (small) with silicone tubing outlet	E2526
200004773	Alumina (aluminium oxide) wool, fine	B1089
200004827	Silica (quartz) wool, very fine	B1208
200004884	O-ring, 18 mm x 2.5 mm	E1556
200005872	Silver wool, 0.05 mm fine wire	B1231
200005999	Quadrang, 7.65 mm x 1.78 mm	E1054
200005999	Quadrang, 7.65 mm x 1.78 mm	E1054-10
200006004	O-ring, 7.5 mm x 2.5 mm	E1069
200006004	O-ring, 7.5 mm x 2.5 mm	E1069-10
200006094	O-ring, 5 mm x 1.5 mm	E1173
200006143	Shaft seal	E1555
200006296	Tin boats 20 x 10 x 9 mm	D5033
200006776	Magnesium perchlorate, self indicating, granular, 0.7 to 1.2 mm	B1141
200006785	Gloves	E2505
200006998	Vacuum grease	E2240
200007012	Filter tube 42 mm	C3074
200007074	Tin boats 12 x 6 x 6 mm	D5131
200007224	O-ring, rubber, 20 mm x 2 mm	E1073
200007224	O-ring, rubber, 20 mm x 2 mm	E1073-10
200007257	Tin boats heavy weight 12 x 4 x 4 mm	D5140

## Cross references TRACE & TOC analysis

Elementar® Part	Description	Part No
200007465	Sodium carbonate	B1602
200007469	O-ring, rubber, 24 mm x 2 mm	E1075
200007469	O-ring, rubber, 24 mm x 2 mm	E1075-10
200007516	Silver capsules smooth wall 5.5 x 3.5 mm	D4102
200007521	Silica (quartz) chips, granular, 2 to 4 mm	B1215
200007543	Tin boats 6 x 4 x 4 mm	D5029
200007554	Copper oxide wires (coarse), 6 x 0.65 mm	B1218
200007754	Silver weighing boats 12 x 6 x 6 mm	D5026
200007811	Platinum catalyst, 5% Pt	B1196
200007811	Platinum catalyst, 5% Pt	B1308
200007844	Combustion/reduction tube	C3009
200007904	O-ring, 16 mm x 3 mm	E1175
200007904	O-ring, 16 mm x 3 mm	E1175-10
200008068	O-ring, 32 mm x 3 mm	E1172
200008184	Smooth wall tin capsules flat base 11 x 4.75 mm	D4121
200008314	O-ring, 4.5 mm x 1.5 mm	E1067
200008314	O-ring, 4.5 mm x 1.5 mm	E1067-10
200008484	Tin foil squares standard weight 50 x 50 mm	D1119
200008689	Aquatak (drying agent) without indicator	B1354
200008714	Drying tube 300 mm (tube only, no caps)	C1143
200008833	Silver weighing boats 6 x 4 x 4 mm	D5127
200009010	Tin foil cones standard weight	D9001
200009010	Tin foil squares standard weight 37 x 37 mm	D1068
200009208	Potassium hydrogen phthalate	B1601
200009554	Copper oxide wires (fine), 4 x 0.5 mm	B1122
200009657	Manually operated drill	E2521
200010160	Brass wool	B1304
200010245	Alumina (aluminium oxide) spheres 3 to 6 mm	B1090
200010387	Silver capsules smooth wall 9 x 3.5 mm	D4109
200010589	O-ring for gripper arm	E1171
200010676	Forceps, stainless steel, curved points - length 130 mm	E2016
200010811	Set of ball valve half shells 14 mm	E2533
200010913	Silver weighing boats 20 x 10 x 9 mm	D5035
200011221	Tin foil squares standard weight 50 x 50 mm	D1118
200011489	Drying tube 348 mm (with GL25 caps)	C3026
200011744	GL18 screw cap	E2518
200011997	Smooth wall tin capsules round base 20 x 8 mm	D4009
200012350	Tin boats 15 x 8 x 8 mm	D5032
200013028	O-ring, 18 mm x 2 mm	E1072
200013169	Cotton wool	E2516
200013224	Smooth wall tin capsules flat base 5.5 x 3.5 mm	D4033
200013285	Smooth wall tin capsules flat base 14 x 6.75 mm	D4120
200013336	Silver weighing boats 12 x 4 x 4 mm	D5039
200013395	Silver weighing boats 15 x 8 x 8 mm	D5034
200013470	Filter tube	C3045
200013646	Cerium dioxide, fused, granular	B1270
200013710	Silver capsules smooth wall 5 x 2 mm	D4103
200013850	Multiwell plate, 24 cell, flat bottom	E2064
200014026	Protection tube 105 mm	C3021
200014026	Protection tube 105 mm (alt to C3021 without slits)	C3059
200014058	Smooth wall tin capsules flat base 6 x 3 mm	D4131
200014191	O-ring, black, 7.59 mm x 2.62 mm	E1087
200014521	Silver capsules pressed 8 x 5 mm	D2008
200014555	Ash finger, quartz, 60 mm	C3018
200014555	Ash finger, quartz, 60 mm, pack of 10	C3060
200014577	Tin boats 12 x 4 x 4 mm	D5130
200014796	Ash crucible, quartz, 60 mm	C3054

The use of OEM part numbers is intended for convenience only, and does not imply that the products are of OEM origin. All Elemental Microanalysis products are guaranteed to be of high quality and are deemed to be suitable alternatives.

Elementar® Part	Description	Part No
200015256	Filter, diameter 18 mm	E1174
200015256	Filter, diameter 18 mm	E1174-10
200015419	Combustion tube, quartz	C3067
200015479	Smooth wall tin capsules flat base 9 x 3.5 mm	D4132

### Shimadzu®

Shimadzu® Part	Description	Part No
035-62994-03	Sleeve set 6F-T, front and back ferrule	E1554
036-11209-84	O-ring 4D P10A	E1550
036-11222-84	O-ring 4D P22	E1551
036-11352-86	O-ring 4D P10A	E1550
036-11352-92	O-ring 4D P22	E1551
036-11408-84	O-ring Teflon P10	E1553
630-00105-01	Platinum gauze discs	D7018
630-00557	Silica (quartz) wool, very fine	B1017
630-00566	Cobaltous/ic oxide granular, 0.85 to 1.7 mm	B1001
630-00635-01	Potassium hydrogen phthalate	B1601
630-00710	IC reagent	B1600
630-00962-01	Sodium carbonate	B1602
630-00963-01	Sodium hydrogen carbonate	B1603
630-00992	Halogen scrubber	X4000
630-00996	High sensitivity catalyst	B1605
630-00999	CO <sub>2</sub> scrubber	X4010
630-01566-00	O-ring AS 568A-116	E1552
630-02591-04	Syringe 250 µl	E7050
630-02591-07	Syringe 2500 µl	E7051
630-08913-01	Chart paper 108 x 50 m	E7072
631-32003	Slider for TOC	E7073
631-41524	Combustion tube	C8060
638-42076	High salt combustion tube	C8061
638-59161-10	5 ml syringe	E7054
638-60202-00	Platinum catalyst for Shimadzu TOC 54 g	B1611
638-60202-01	Platinum catalyst for Shimadzu TOC 71 g	B1610
638-60239-41	Cobaltous/ic oxide granular, 0.85 to 1.7 mm	B1001
638-60240-41	Sodium carbonate	B1602
638-60241-41	Potassium hydrogen phthalate	B1601
638-60242-41	Sodium hydrogen carbonate	B1603
638-60246	Platinum catalyst-ST for Shimadzu TOC	B1609
638-60734-05	Teflon syringe tips for 250 µl syringe	E7052
638-60734-08	Teflon syringe tips for 2500 µl syringe	E7053
638-92069-02	TC catalyst set	B1607
638-92070-01	High sensitivity TC catalyst set	B1606

### Skalar®

Skalar® Part	Description	Part No
90035245	Quartz wool discs, 15 mm diameter	B1250
90050628	Brass wool	B1313
90050629	Steel wool	B1170
2CA10359	Silica (quartz) wool, very fine	B1208
2CA16353	Aluminium oxide carrier	B1315
2NC22140	Large scrubber tube, 310 mm, borosilicate	C8103
2NC22141	He ref. scrubber tube, 120 mm, borosilicate	C8104
2SN100061	Brass scrubber tube, 220 mm, borosilicate	C8105
2SN100062	Small scrubber tube, 220 mm, borosilicate	C8102
2SN100099	Quartz tube, Cu reductor	C8101
2SN20352	Copper oxide wires (coarse) 6 x 0.65 mm	B1608
2SN20354	Anhydrone - water absorber	B1312
2SN20355	EMASorb II B granular, 8-20 mesh, CO <sub>2</sub> absorbant	B1325
2SN20357	Copper reductor	B1314



## Cross references TRACE & TOC analysis

### Thermo Euroglas®

Thermo Euroglas® Part	Description	Part No
CASSE0002	Glass part for liquids module, model MODUL0007	C5120
CASSE0012	Glass part for liquids module, model MODUL0019	C5121
CHEM00029	HiPerTOC TN-CLD catalyst	B1661
DEXTAR0014	DeXtar combustion tube, plus macr.	E7631
ECA170012	Boat ECA1700	E7633
ECS100006	Thermocouple furnace ECS1000	E7637
ECS100007	Heating element furnace ECS1000	E7638
ECS100019	Euroglas rec paper -10/+100	E7640
ECS100022	Cable set ECS1000	E7641
ECS300006	Sulfuric acid scrubber 3000	E7645
ECS300009	Connection furn scrub 3000	E7646
ECS300010	Connector to gas inlet 3000	E7647
EFU100002	Sample container EFU 1000	E7649
EFU100003	Quartzfrit holder POM EFU 1000	E7650
EFU100005	Silicon seal EFU1000 23/9	E7651
EFU100010	Screwcap GL-45 with conn. EFU1000	E7652
EGM170007	Expansion vessel coated	E7653
EGM170014	Euroglas metal sample loop	E7510
EGM170016	Capillary for EGM	E7654
ELS200003	Screw caps for vials	E7604
ELS200014	Tubing PEEK 1/16" x 0,01" P.2FT	E7655
ELS200015	PEEK fitting & ferrule one piece	E7656
ELS200032	Valco furnace needle coupler internal union, 1/16" tubing 0.50 mm bore	E7607
ELS200042	Clear vial 2 ml 12 x 32 mm, screw thread	E7602
ELS210018	Needle EURO10 213 mm PS5 GA22 pack of 3	E7657
ELS210023	Motor with gear box X & Y axes	E7658
ELS300005	Sampler needle for ELS3000	E7660
ELS300006	Septa, PTFE, 7.7 mm, silicone lined, for caps	E7603
ELS300019	718/A needle to syringe tube	E7663
ELS300020	Needle guide for ELS3000/NEXYZ sampler	E7664
ELS300028	Needle seat port, ELS3000 & NEXYZ	E7667
ELS300063	Spring for guide needle	E7669
ELS300071	Plunger for syringe TCS 250µl	E7670
ESA200004	Introduction port seal ESA2000, 5 pieces	E7672
ESA200019	Grabber element for ESA2000	E7675
ESA200029	Sample cups, small	E7676
HIPER0420	Quartz inlay for combustion tube HiperTOC	C5124
HIPER6001	IR lamp assy, inc. Alu reflector	E7863
MODUL0001	POX sample introduction module	E7680
MODUL0002	Solids Module	E7681
MODUL0003	Boatguiding tube solids	E7682
MODUL0004	Quartz combustion boat, solids	C5115
MODUL0006	Stopper with septum solids	E7683
MODUL0007	Liquids sample (syringe) introduction module, 1200 series	E7684
MODUL0008	AOX sample introduction module	E7685
MODUL0009	Boat guiding tube AOX	C5125
MODUL0010	Quartz combustion boat, AOX	C5116
MODUL0019	Liquid sample introduction module, 3000 series	E7688
PANAL0004	Stirrer motor titration cell	E7690
PANAL0005	Stirrer bar for 35 ml cell	E7691
PANAL0008	Generation electrode AG SB CEL	E7692
PANAL0009	Measuring electrode AG SB CEL	E7693
PANAL0013	Potassium chloride 3M saturated with silver chloride	B1650

The use of OEM part numbers is intended for convenience only, and does not imply that the products are of OEM origin. All Elemental Microanalysis products are guaranteed to be of high quality and are deemed to be suitable alternatives.

Thermo Euroglas® Part	Description	Part No
PANAL0021	Gas inlet 35 ml titration cell	E7696
PANAL0022	Sulfuric acid scrubber 1200	E7697
PANAL0023	Splashbulb ECS1200	E7698
PANAL0025	Septum, 12.5 mm diameter	E7505
PANAL0029	Connection furnace/scr. 1200	E7699
PANAL0035	Ink ribbon ERC23	E7521
PANAL0036	Printer paper roll - column printer	E7520
PANAL0038	Halogens scrubber	E7700
PANAL0046	Halogen titration cell - capillary	E7701
PANAL0047	Electrode container capillary cell incl. o-ring	E7702
PANAL0049	Euroglas generating electrode, Ag	E7501
PANAL0050	Euroglas measuring electrode, Ag	E7502
PANAL0051	Cathode platinum capillary cell	E7704
PANAL0052	Euroglas halogen reference electrode	E7500
PANAL0056	NOX scrubber	E7705
PANAL0065	Quartz combustion tube universal	C5101
PANAL0068	Turbo combustion tube	C5102
PANAL0072	Sulfur-cell iodometric 35 ml	E7706
PANAL0073	Electrode container, 35 ml cell	E7707
PANAL0074	Generating electrode, Pt, 35 ml cell	E7708
PANAL0075	Measuring electrode, Pt, 35 ml cell	E7709
PANAL0076	Sulfur reference electrode, Pt	E7710
PANAL0082	Gas inlet 10 ml S-cell	E7711
PANAL0086	Vaseline 50 g	B1660
PANAL0092	Cathode, Pt	E7712
PANAL0106	Silver wool	B1665
PANAL0123	Gas outlet tube	E7713
PANAL0125	Combustion tube universal model 3000	C5103
PANAL0126	Turbo tube model 3000	C5100
PANAL0161	Paper filter, TN only,	E7715
PANAL0162	Glass connector outlet	C5113
PANAL0205	Nickel sample cups, 5 pieces	D8600
PANAL0267	Clear vial 40 ml 27 x 95 mm unwashed EPA/VOA pk 100	E7608
PELEC0031	Solid state relay	E7723
PELEC0042	FAN 12 V DC 60 x 60 x 25	E7722
PELEC0061	FAN 115 Volt 50/60 hertz	E7724
PELEC0076	Temp sensor PT100 POX	E7725
PELEC0132	Thermocouple 1200/3000 series	E7726
PELEC0143	Klixon 100 °C	E7728
PELEC0234	NTC 4 Ohm 2 units	E7729
PELEC0259	UNCO2 control board	E7730
PELEC0325	E17 interface board	E7731
PELEC0371	Cableset ECS 1200/3000	E7732
PELEC0461	Heating element 8 mm EGM	E7733
PELEC0583	Varistor, 2 units	E7734
PELEC0611	TS/UV board 4819	E7736
PGENE0001	Syringe, 100 µl, 71 mm PS2	E7540
PGENE0002	Syringe, 100 µl, 71 mm, PS5 GA22	E7541
PGENE0004	Needle, 71 mm, PS5 GA22	E7530
PGENE0005	Needle Euroglas 150 mm, pack of 3	E7531
PGENE0006	Needle Euroglas 71 mm, pack of 3	E7532
PGENE0008	Syringe, 10 µl, 150 mm	E7544
PGENE0029	Catalyst, Pt on ceramic base	E7737
PGENE0030	Needle Euroglas 120 mm, pack of 3	E7533
PGENE0031	Permapure	E7545
PGENE0032	Inner tube of permapure dryer only	E7738
PGENE0034	Presto syringe 50 ml luer lock	E7739
PGENE0035	Syringe, 100 µl, 120 mm, PS5	E7542
PGENE0038	Needle Euroglas 120 mm, pack of 3	E7534
PGENE0039	Syringe, 100 µl, 120 mm, PS2	E7543

## Cross references TRACE & TOC analysis

Thermo Euroglas® Part	Description	Part No	Thermo Euroglas® Part	Description	Part No
PGENE0052	Glass fibre filters 5 µm, 10 pcs	E7740	PMECH0869	MFC, 3 channel, factory refurbished	E7807
PGENE0060	Needle 213 mm, GA22, PS3, 3 pcs	E7741	PMECH0882	Elbow, 5 x 4 mm	E7808
PGLAS0032	Quartz samplecup AOX column method	E7742	PMECH0892	Push-in coupling 5 mm x 1/8"	E7809
PGLAS0077	Quartz wool, 10 g	B1278	PMECH0973	1/8" tubing red (Ar), gas supply incl. nuts	E7810
PGLAS0111	Buret plug NS 12.5 x 27 mm, M8	E7868	PMECH0974	1/8" tubing blue (O <sub>2</sub> ), gas supply incl. nuts	E7811
PGLAS0140	Stop zeskant vlak hol NS 10	E7743	PPTRE0011	Spoon, stainless steel, for activated carbon	E7812
PGLAS0602	Quartz combustion boat AOX ESA	E7746	PPTRE0012	Activated carbon, AOX, COL 50 g	B1652
PINJE0002	Septum diam. 24 mm POX 10 pcs	E7752	PPTRE0013	Polycarbonate filter 100 pcs	E7813
PINJE0004	POX sample bottle 100 ml	E7753	PPTRE0017	Piston & stamp	E7814
PINJE0006	POX needle 81 mm PS 5 (set of 3)	E7754	PPTRE0018	Ceramic wool square 20 x 20 cm	B1664
PINJE0007	POX needle 32 mm PS 5 (set of 3)	E7755	PPTRE0020	Filled micro-columns, pk 100	B1651
PINJE0008	Washbottle (foambr) POX	E7756	PPTRE0022	Ejection tool	E7815
PINJE0004	POX sample bottle 100 ml	E7753	PPTRE0033	Funnel for activated columns	E7816
PINJE0012	Quartz sample boat, Euroglas	C5110	PPTRE0034	Filling tray for 50 micro columns	E7817
PINJE0018	Quartz sample boat, Euroglas	C5111	PPTRE0047	Quartzfrit	C5114
PMECH0006	KS clamp with screw Nr. 12	E7757	PPTRE0049	Activated carbon, AOX, batch PPTRE0049, 50 g	B1653
PMECH0008	PTFE sleeve NS-29/32, 10 pcs	E7871	PPTRE0064	Quartz sample cup poly-carbo	E7819
PMECH0010	Screwcap SQ 13/7	E7758	PPTRE0065	Activated carbon, AOX, batch PPTRE0065, 50 g	B1655
PMECH0014	PTFE tubing 1/8 PTFE natural with red stripe	E7759	PRESTO1005	Connector bulkhead 6 x 6	E7820
PMECH0029	Tubing 4 x 2 mm PTFE red stripe	E7760	PRESTO1006	Connector elbow 6 x 1/8 G	E7821
PMECH0030	Needle valve	E7761	PRESTO1007	Connector straight 6 x 1/8 G	E7822
PMECH0031	O-ring teflex FEP/Sil	E7762	PRESTO1021	Bulkhead push-in 10 mm	E7823
PMECH0040	Clamp fork NS 29	E7872	PRESTO1029	Stepper motor, assy	E7824
PMECH0042	Screwcap with GL-14 bore	E7866	PRESTO1039	Column holder	E7825
PMECH0043	Screwcap with bore GL-32	E7763	PRESTO1040	Column end closure	E7826
PMECH0044	Screwcap with bore GL-25 POX-B	E7764	PRESTO1042	Insert with screw 10 mm & O-ring	E7827
PMECH0154	Quick connector female, blue (oxygen)	E7775	PRESTO1049	Column connector luer lock	E7828
PMECH0155	Quick connector, male, blue (oxygen)	E7776	PRESTO1050	Column holder luer lock	E7829
PMECH0156	Quick connector, male, white (argon)	E7777	PRESTO1056	Push reducing straight	E7830
PMECH0157	Quick connector, female, white (argon)	E7778	REPKIT0029	Rep kit 1200 furnace scrubber conn	E7833
PMECH0059	Red. union 1/8" OD x 1/4" OD nylon	E7766	SPHINCX0025	Power supply for sphincx	E7834
PMECH0060	1/4" OD union nylon	E7767	TN3000003	Vacuum pump	E7835
PMECH0061	1/4" OD union elbow nylon	E7768	TN3000029	Perma Pure dryer	E7511
PMECH0096	P.O.X. prikker M143/287	E7771	TN3000030	In-line filter	E7837
PMECH0113	Push-in connector, M5-4 mm	E7772	TN3000031	Control board TN3000 (UNCO version)	E7838
PMECH0124	Push-in connector, ID 4 mm	E7773	TN3000041	Electronic ozone killer	E7839
PMECH0130	Hinge black, 1200 & older 3000 series	E7774	TN3000042	Molybdenum convertor assy	E7840
PMECH0154	Quick connector female, blue (oxygen)	E7775	TN3000052	Reaction chamber, TN	E7841
PMECH0155	Quick connector male, blue (oxygen)	E7776	TN3000067	Nickel cup/boat, high salt, set of 3	D8602
PMECH0156	Quick connector, male, white (argon)	E7777	TOC120037	Copper oxide scrubber	C5112
PMECH0157	Quick connector female, white (argon)	E7778	TS3000003	UV scrubber	E7847
PMECH0287	Oven, 1200 series/DeXtar	E7781	TS3000006	Flashlamp for TS-UV	E7848
PMECH0368	Red union, D1/4 D04 PTFE	E7783	TS3000010	Connection scrubber/filter	E7849
PMECH0383	Oven model 3000/4000, including frame	E7784	TS3000014	Non return vessel, TS	E7850
PMECH0387	Bulkhead, 4 OD x 1/8 OD, brass	E7785	XVI0028	Wool puller, mini	E7600
PMECH0390	Tubing, 4 x 2 mm, PTFE blue stripe	E7786	XVI0029	Tube, ceramic 1/4" x 4.7 mm x L340 mm	E7852
PMECH0394	Fast connector for Xprep 3 & EFU1000	E7787	XVI0039	Quartz furnace tube, XVI-HYDRO	E7855
PMECH0507	Elbow, red. union, 1/8" x 1/4", PTFE	E7791	XVI0040	Quartz tube preheater	E7856
PMECH0528	1/4" OD PTFE tubing	E7792	XVI0041	11 mm septum, blue, pack of 10	E7601
PMECH0696	O-ring black FBA 1.78 mm, 10 pcs	E7794	XVI0075	O-ring, Kalrez	E7864
PMECH0763	Elbow, red union, 4 mm x 1/4", PTFE	E7796	XVI0076	O-ring, Kalrez	E7865
PMECH0826	Union 1/4 x 1/4 PTFE	E7800	XVI0112REP	Furnace for XVI+ 300W factory repair	E7859
PMECH0828	MFC, 1 channel, factory refurbished	E7801	XVI0114	SIC heater element, L230	E7860
PMECH0835	Tee-piece, push-in connector, 4-4-4 mm	E7802	XVI0129	Thermocouple S, furnace XVI0112	E7861
PMECH0845	Quick connector male, PP, PMC12-04-12	E7803	XVI0130	Perma pure heated for XVI+	E7862
PMECH0846	Quick connector female, PMC14-04M42	E7804			

The use of OEM part numbers is intended for convenience only, and does not imply that the products are of OEM origin. All Elemental Microanalysis products are guaranteed to be of high quality and are deemed to be suitable alternatives.



## Products from Elemental Microanalysis

Operating from Devon, UK, our business holds three separate certifications and accreditations: ISO 9001 for our huge product range, supplying customers worldwide with high quality analytical consumables at value prices; ISO 17025 for our analytical services laboratory; and ISO 17034 for our new range of certified standards. Our qualified despatch and customer services teams can organise safe, speedy and economical shipment of your orders worldwide by air, road or sea.

	SAMPLE ENCAPSULATION	GLASSWARE AND FURNACE TUBES	CHEMICAL REAGENTS	REFERENCE MATERIALS	OTHER PARTS AND CONSUMABLES
CHNOS (MICRO) ANALYSIS					
N/PROTEIN DUMAS ANALYSIS					
INORGANIC ANALYSIS					
ORGANIC C/S ANALYSIS					
MACRO CN/CHN/CNS ANALYSIS					
CF-IRMS ANALYSIS					
TRACE AND TOC ANALYSIS					

These pictures show only a small fraction of the thousands of products we have available for combustion elemental analysis. For further information please request our catalogue for the application area you are interested in. We can also provide Product Sheets giving a list of consumables specific to your analyser.



*New from Elemental Microanalysis*

**ICP-MS cones**

compatible with:  
 Agilent Technologies®  
 NU Instruments Ltd  
 PerkinElmer®  
 Shimadzu®  
 Thermo Fisher Scientific®

Visit our website,  
[www.elementalmicroanalysis.com](http://www.elementalmicroanalysis.com),  
 for up-to-date information, product releases,  
 news, and to subscribe to our mailing list.





Elemental Microanalysis Ltd.  
1 Hameldown Road  
Okehampton  
Devon EX20 1UB  
United Kingdom  
Tel: +44 (0)1837 54446  
Email: [enquiries@microanalysis.co.uk](mailto:enquiries@microanalysis.co.uk)

CRMs, Consumables & Spares: [www.elementalmicroanalysis.com](http://www.elementalmicroanalysis.com)

Lab Analysis: [www.elementallab.co.uk](http://www.elementallab.co.uk)

